

H&R

GENADYNE
accelerated wound healing solutions



GENADYNE DUO NPWTi-d USER MANUAL

CONTENTS

1.	SAFETY STANDARDS	4
2.	INTRODUCTION	5
3.	USER	5
4.	INDICATIONS FOR USE	5
5.	CONTRA-INDICATION	6
6.	WARNINGS	6
7.	PRECAUTIONS	7
8.	WOUND ODOR	8
9.	PHYSICIAN ORDERS	8
10.	DRESSING CHANGES	8
11.	CANISTER SELECTION	9
12.	DEVICE USAGE INFORMATION	10
	12.1 <i>Device Size and Usage Posture</i>	10
	12.2 <i>Operating the Device</i>	11
	12.2.1 <i>Device On and Off</i>	11
	12.3 <i>Description of Duo Device Components</i>	11
	12.4 <i>Preparation for Use</i>	13
	12.4.1 <i>Device Case</i>	13
	12.4.2 <i>Canister Application</i>	14
	12.4.3 <i>Preparation of Instill</i>	15
	12.4.4 <i>Power Connection</i>	16
	12.4.5 <i>Using IV Pole Clamp</i>	17
13.	THERAPY MODES	17
	13.1 <i>Continuous Mode</i>	18
	13.2 <i>Variable/Intermittent Mode</i>	20
	13.2.1 <i>Variable Mode Settings</i>	20
	13.3 <i>Instill Mode</i>	23
	13.3.1 <i>Instill Mode Setting</i>	24
14.	OTHER SCREENINGS AND SETTINGS	27
	14.1 <i>Utilities</i>	29
15.	ALARMS	32
16.	MAINTENANCE, SERVICE, and SETUP MENU	36
17.	BATTERY POWER	37
18.	COMPONENTS AND ACCESSORIES USED WITH THE DUO SYSTEM	38
19.	DRESSING APPLICATION	39
20.	DUO CLINICAL GUIDELINES	40
	20.1 <i>DUO Pressure Settings</i>	40
21.	RETURNING THE DEVICE	40
22.	LIMITED WARRANTY	41
23.	TECHNICAL SPECIFICATIONS	41
24.	ELECTROMAGNETIC COMPATIBILITY	42
25.	CONTACT INFORMATION	44
26.	LABEL	44

FIGURES

Figure 1 DUO Device Dimensions.....	10
Figure 2 DUO Device Standing Position	10
Figure 3 DUO Device On.....	11
Figure 4 DUO Device Off	11
Figure 5 DUO Front Screen View.....	11
Figure 6 DUO Device - Right.....	12
Figure 7 DUO Device - Left.....	12
Figure 8 DUO Device Back.....	13
Figure 9 DUO Device Case.....	13
Figure 10 DUO Device Case and Components	13
Figure 11 DUO Device Bottom Base.....	14
Figure 12 DUO Canister Attachment Steps.....	15
Figure 13 DUO Install Preparations Steps.....	16
Figure 14 DUO Device Power Supply	16
Figure 15 Connecting the Power Supply to the Device	17
Figure 16 IV Pole Clamp	17
Figure 17 Continuous Mode Therapy Selected.....	18
Figure 18 Setting Treatment Parameters of Continuous Mode	19
Figure 19 Continuous Mode Treatment Screen.....	19
Figure 20 Setting Parameters when the device operating screen.....	20
Figure 21 Variable Mode Therapy Selection.....	21
Figure 22 Setting Treatment Parameters of Variable Mode	21
Figure 23 Variable Mode Therapy Screen.....	22
Figure 24 Setting Parameters when the device operating screen.....	22
Figure 25 Instill Mode Treatment Selection.....	24
Figure 26 Setting Treatment Parameters of Instill Mode	25
Figure 27 Volumeter (Instill Assist)	26
Figure 28 Instill Mode Treatment Screen	26
Figure 29 Setting Parameters when the device operating screen.....	27
Figure 30 Device lock and unlock.....	27
Figure 31 Active Therapy Modes Other Selections.....	28
Figure 32 DUO Device History Records	29
Figure 33 DUO Device Utilities Screen	29
Figure 34 DUO Regional Settings	30
Figure 35 DUO Brightness and Sound Settings	31
Figure 36 Alarm Settings Screen	31
Figure 37 Alert Sensitivity	31
Figure 38 Service Setting Screen.....	32
Figure 39 DUO Information Screen.....	32
Figure 40 Leak Alarm Screen.....	33
Figure 41 Canister Full Alarm Screen	33
Figure 42 Blockage Alarm Screen.....	33
Figure 43 Instill Blockage Alarm Screen	34
Figure 44 Low Battery Alarm Screen.....	34
Figure 45 Solution Bag Empty Alarm Screen.....	34
Figure 46 Instill Door Open Alarm Screen.....	35
Figure 47 Instill Door Closed Alarm Screen.....	35
Figure 48 DUO Management Software (DUO Connect)	37
Figure 49 Device Application Model	40
Figure 50 DUO Device Label.....	44

1. SAFETY STANDARDS

When using electrical devices, basic safety precautions should always be followed when children are present, including the following.

DANGER

To reduce the risk of electrocution:

1. ALWAYS unplug this product immediately after using or when charging is completed.
2. DO NOT use while bathing.
3. DO NOT place or store product where it can fall or be pulled into a tube or sink.
4. DO NOT place or drop into water or other liquid.
5. DO NOT reach for a product that has fallen into water. Unplug immediately.

WARNING

Using external accessories and cables other than those provided by Genadyne may result in increased electromagnetic emissions or a decrease in the immunity of the wound vacuum system.

When the Genadyne accessories (*Equipment classification Isolation type BF applied part*) are used, patient leakage current will not exceed limits set for this device.

The USB port is blocked by tape. Removing the tape invalidate the Warranty. The use of the USB port is strictly limited to *Authorized Personnel*.

Warning: Disregarding the information on safety of this device is considered ABNORMAL USE. Only use the device in accordance with this manual and applicable product labels.

To reduce the risk of burns, electrocutions, fire or injury to persons:

1. This product should never be left unattended when plugged in.
2. Close supervision is necessary when this product is used near infants or children
3. Use this product only for its intended use as described in this manual. DO NOT use attachments or kits not recommended by Genadyne.
4. NEVER operate this product if it has a damaged cord or plug, any missing components, is not working properly, has been dropped or damaged or has been dropped into water.
5. Keep the cord away from heated surfaces.
6. Do not use in presence of flammable anesthetics.
7. DO NOT operate where aerosol (spray) products are being used or where oxygen is being administered.
8. The AC ADAPTER should be unplugged from the outlet when not in use. When unit is not going to be used for an extended period of time, store carefully in a cool, dry place.
9. The user SHOULD NOT attempt to service or repair the Wound Vacuum System. Refer all servicing to Genadyne or *authorized Genadyne distributor*. There are no user-serviceable parts inside.

As with all prescription medical devices, failure to follow product instructions or adjusting settings and performing therapy applications without the Express direction and/or supervision of your trained clinical caregiver may lead to improper product performance and the potential for serious fatal injury. For medical questions, please consult a physician. In case of medical emergency, immediately contact your local emergency services provider. Caution: Federal Law (USA) sells this device on the order of a licensed physician.

2. INTRODUCTION

The information provided in this user guide contains important information about the safe and effective operation of Genadyne DUO Negative Pressure Wound Therapy with the Instill (NPWTi-d) system. It can be used as a personal reference and also for staff training. Preventive maintenance, cleaning, and disposal information are also included.

The Genadyne DUO is an advanced wound healing therapy that can be readily integrated into a clinician's wound healing practice to optimize patient care. It is suitable for use in hospitals and Long-Term Care.

The DUO NPWT system is designed for patients who can benefit from Negative Pressure Wound Therapy (NPWT) and Negative Pressure Wound Therapy with Instillation (NPWTi-d). This device may promote wound healing by removing excess exudate, infectious materials, and tissue debris. It is indicated for patients with chronic, acute, traumatic, subacute, and dehisced wounds, as well as partial thickness burns, pressure ulcers, diabetic ulcers, venous ulcers, flaps, and grafts.

Points to remember

1. Follow standard infection control precautions.
2. Ensure that the wound is suitable for the DUO Negative Pressure Wound Therapy.
3. Read and follow all user instructions and safety information that accompanies the DUO.
4. Do not place DUO dressings directly over exposed organs, blood vessels, and/or nerves.
5. Complete proper debridement prior to application of DUO.
6. Do not leave the DUO dressing in place if therapy is switched off for more than 2 hours; if this occurs, remove it and replace it with a new NPWT dressing or alternative dressing as ordered.
7. Always count and record the number of foam pieces used in the patient chart. During dressing removal, ensure the same number of pieces are removed to verify that all foam has been removed.
8. If there is no visible improvement in the wound within two weeks, consult the treating physician to reassess and potentially adjust the treatment plan.

Duo Safety Information

All disposable components of the DUO are for single use only.

All contents within the DUO foam kits are sterile and latex-free.

The DUO foam kits are only for use with the Genadyne DUO.

The decision to use a clean sterile/aseptic technique depends on wound pathophysiology, physician/clinician preference, and institutional protocol.

Important

Like any prescription medical device, failing to consult a physician and thoroughly reading and following all therapy unit and dressing instructions, along with safety information, before each use may result in improper product performance and possibly serious or fatal injury.

3. USER

The Genadyne DUO system is intended for use by healthcare professionals and authorized personnel.

4. INDICATIONS FOR USE

The Genadyne DUO is designed for use in both acute and *chronic* wounds. It is intended for patients who could benefit from negative pressure wound therapy, especially since the device may enhance wound healing by removing excess exudates, infectious materials, and tissue debris. It is suitable for patients with chronic, acute, traumatic, subacute, and dehisced wounds, as well as partial-thickness burns, pressure ulcers, diabetic ulcers, venous ulcers, flaps, and grafts.

5. CONTRA-INDICATION

- Exposed arteries, veins, organs, or nerves
- Anastomotic sites
- Malignancy in the wound
- Untreated osteomyelitis
- Non-enteric and unexplored fistulas
- Necrotic tissue with eschar present

6. WARNINGS

Bleeding: The following types of patients are at increased risk of bleeding, which, if uncontrolled, could be potentially fatal:

- Patients who would have weakened or friable blood vessels or organs in or around the wound as a result of, but limited to:
 - Suturing of blood vessels
 - Infection
 - Trauma
 - Radiation
- Patients without adequate wound hemostasis
- Patients who have been administered anticoagulants or platelet aggregation inhibitors
- Patients who do not have adequate tissue coverage over vascular structures

If sudden active bleeding occurs, or if a significant amount of frank (bright red blood is present in the tubing or canister, immediately stop the therapy, keep the dressing in place, take appropriate measures to control the bleeding, and seek immediate medical assistance. The DUO should not be utilized to prevent, reduce, or stop vascular bleeding.

- **Protect vessels and organs.** All exposed or superficial vessels and organs in or around the wound must be completely covered and protected prior to the administration of the DUO. **Caution** should be taken when treating large wounds that may contain hidden vessels that may not be readily apparent. The patient should be closely monitored for bleeding in a setting deemed appropriate by the treating physician.
- **Infected Blood Vessels.** Infection may erode blood vessels and weaken the vascular wall, which may increase susceptibility to vessel damage through abrasion or manipulation. The patient should be closely monitored for bleeding in a care setting deemed appropriate by the treating physician.
- **Hemostasis, Anticoagulants, and Platelet Aggregation Inhibitors.** Due to the increased risk of bleeding, the negative pressure setting and therapy mode should be considered when initiating therapy. These patients should be treated and monitored in a care setting deemed appropriate by the treating physician.
- **Hemostatic Agents Applied at the Wound Site.** *Patients suffering from difficult hemostasis or receiving anticoagulant therapy have an increased risk of bleeding. During treatment, avoid using hemostatic products that may increase the risk of bleeding. This status, if uncontrolled, could be potentially fatal.*
- **Shape Edges or bone fragments** must be covered or eliminated from the wound area to prevent them from puncturing blood vessels or organs before the application of the DUO. Use caution when removing dressing components from the wound so that the wound tissue is not damaged by unprotected sharp edges.

Vascular Surgical Wounds of the Lower Extremities: Regardless of the treatment, wound complications from peripheral vascular surgery, especially those in the groin, have the potential for severe consequences, including significant blood loss. Please refer to the information on managing vascular surgical wounds of the lower extremities.

Infected Wounds: Should be closely monitored and may require more frequent dressing changes. If there are any signs of the onset of systemic infection or advancing infection at the wound site, contact the treating physician immediately to determine if the DUO should be discontinued.

Osteomyelitis: DUO should not be initiated on a wound with untreated osteomyelitis.

Tendons, Ligaments, and Nerves: Protect exposed tendons, ligaments and nerves with natural tissue, meshed non-adherent material or bio-engineered tissue to help minimize risk.

Foam Placement: Always use dressings from sterile packages that have not been opened or damaged. Do not place any foam dressing into blind/unexplored tunnels. Always count the total number of pieces of foam used in the wound and document on the patient chart.

Foam Removal: Always count the total number of pieces of foam removed from the wound and ensure the same number of foam pieces are removed as were placed, as the dressings are not bioabsorbable. Regardless of treatment, disruption of the new granulation tissue during any dressing change may result in bleeding at the wound site.

Keep DUO Turned On: Never leave the foam dressing in place with the DUO off for more than 2 hours. If the therapy is off for more than 2 hours, remove the DUO dressing and irrigate the wound. Then, either apply a new DUO dressing and restart the unit or, at the physician's direction, apply an alternative dressing.

Defibrillation: If defibrillation is required in the area where the dressing is placed, remove the dressing. Failure to remove it may inhibit the transmission of electrical energy and/or patient resuscitation.

Magnetic Resonance Imaging (MRI): Do not take the DUO into the MRI environment. The dressing can typically remain on the patient with minimal risk. Silver Foam must be removed. If the MRI lasts more than 2 hours, the dressing must be changed.

Hyperbaric Oxygen Therapy (HBO): The DUO unit is not designed for the HBO environment and should be considered a fire hazard. Disconnect the DUO and replace the dressing with another HBO-compatible material during the hyperbaric treatment. If the dressing is left in place, cover the luer lock end with gauze and leave the port unclamped. If treatment is longer than 2 hours, the dressing must be changed.

Instill Solution: The clinician must determine, based on the patient's condition, the solution to be used with DUO.

7. PRECAUTIONS

Standard Precautions: To reduce the risk of transmission of blood-borne pathogens, standard precautions for infection control should be applied to all patients as per institutional protocol.

Continuous vs. Variable/Intermittent Therapy: Continuous therapy is recommended over unstable structures to help minimize movement and stabilize the wound bed. Continuous therapy is generally recommended for patients at increased risk of bleeding, highly exudating wounds, fresh flaps and grafts, and wounds with acute enteric fistulae. Variable mode helps speed up granulation tissue formation and encourage blood flow at the wound edge.

Instillation Therapy: The clinician must determine the configuration of instill volumes and periods based on the wound volume and the content of the solution selected.

Patient Size and Weight: Patient size and weight should be considered when prescribing the device. DUO has not been studied on pediatric patients. Elderly patients should be closely monitored for fluid loss and dehydration. Also, patients with highly exudating wounds or large wounds in relation to the patient size and weight should be closely monitored.

Bradycardia: To minimize the risk of bradycardia the DUO is not to be placed near the vagus nerve.

Enteric Fistulas: Special precautions are necessary to optimize DUO. Its use is not recommended if the sole purpose of using the DUO is to manage effluent containment.

Circumferential Dressing Application: Avoid using circumferential dressings. If a circumferential application is necessary, consider using several small pieces of drape to reduce the risk of decreased distal circulation. Do not stretch or pull the drape while securing it. It is essential to palpate distal pulses and assess distal circulatory status.

Additional Information for Genadyne Silver Dressings: When using silver foam, avoid using any topical solutions or agents that may cause an adverse reaction to the silver. Do not use silver foam if the patient is known to be sensitive to Silver or metal. *Do not allow the silver foam to contact electrodes or conductive gels.*

8. WOUND ODOR

Wounds treated with DUO NPWT system may have an odor due to foam dressing and wound fluids, which contain bacteria and protein. The type of bacteria and protein present may be responsible for the type and strength of the odor.

- It is important to clean the wound thoroughly during each dressing change to minimize odor and decrease bacteria.
- If malodor remains after thorough cleaning, this may be a sign of possible infection.
- The DUO canister may need to be changed more often to control odor.
- If DUO NPWT system is determined to be the source of odor, contact your distributor.

9. PHYSICIAN ORDERS

As a condition of use, the DUO system should only be used by qualified and authorized personnel. The user must have the necessary knowledge of the specific medical application for which Negative Pressure Wound Treatment is being used.

Prior to placing the Genadyne DUO, the medical professional treating the wound assesses how best to use the system for each individual wound. It is important to carefully assess the wound and patient to ensure clinical indications for Negative Pressure Wound Therapy (NPWT) are met.

All orders should include:

- Wound location, size, and type
- Dressing kit type
- Vacuum setting
- Frequency of dressing changes
- Adjunctive dressing

10. DRESSING CHANGES

Wounds being treated with the Genadyne DUO system should be monitored regularly. In a monitored, non-infected wound, Genadyne DUO dressings should be changed every 48 to 72 hours after the initial application of therapy. If no leak is present and the patient is comfortable, subsequent dressing changes should occur no less than 3 times per week, with frequency adjusted by the clinician as appropriate. Infected wounds may require more frequent dressing changes. As NPWT is not intended to treat infection directly, if there are any signs of systemic infection or advancing infection in the wound area, contact the treating clinician immediately.

When dressing a wound involving difficult-to-seal anatomy or exposure to external moisture, frequent inspection of the dressing is recommended to ensure a seal is maintained. Ensure wound dressing is fully compressed and firm to the touch.

11. CANISTER SELECTION

The Genadyne DUO system can only be used with Genadyne DUO canisters. The canister should be changed at least once a week or when it is full. If exudate levels are high, canisters may have to be changed regularly within single-patient treatment episodes.

The Genadyne DUO NPWT system is available in three different volumes of DUO canister: 600 cc, 800 cc, and 1100 cc. Canisters are sterile and disposable. Do not re-use and re-sterile.

12. DEVICE USAGE INFORMATION

This user manual contains important information regarding the safe and effective operation of the Genadyne DUO Negative Pressure Wound Therapy with Instill (NPWTi-d) system. It can be used as a personal reference and in personnel training. Preventive maintenance, cleaning, and disposal information are also included.

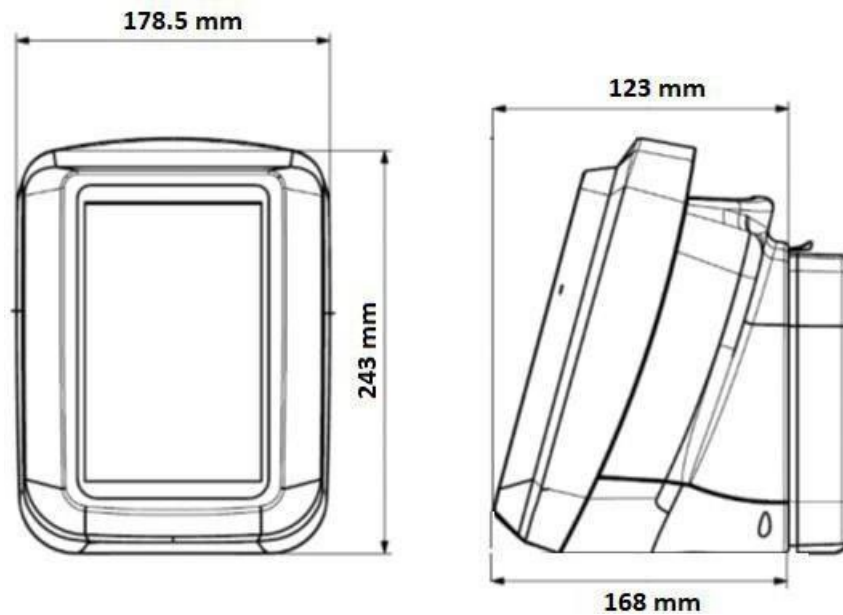

Figure 1 DUO Device Dimensions

12.1 Device Size and Usage Posture

The DUO must be used only at this suggested orientation.



Figure 2 DUO Device Standing Position

12.2 Operating the Device

12.2.1 Device On and Off



Figure 3 DUO Device On

Device On: Simply press the ON/OFF power button of the device once. Do not press and hold.



Figure 4 DUO Device Off

Device Off: Press the On/Off button for 3 seconds to turn off the device until the power off progress bar on the screen is full.

12.3 Description of Duo Device Components



Figure 5 DUO Front Screen View



Figure 6 DUO Device - Right



Figure 7 DUO Device - Left



Figure 8 DUO Device Back

12.4 Preparation for Use

12.4.1 Device Case

The device case includes a DUO pump, adapter, and IV Pole Clamp. It should be checked that all these contents are complete and that there is no damage. In case of damage or missing components, contact the manufacturer.



Figure 9 DUO Device Case



Figure 10 DUO Device Case and Components

Device Label Check

The device *label* contains the serial number of the device, the date of manufacture, and the reference number. The label is important for device traceability and tracking.

The security label is important so that the inside of the device is not opened. *If the inside of the device is opened, it turns itself off.*



Figure 11 DUO Device Bottom Base

12.4.2 Canister Application

DUO Negative Pressure Wound Therapy System has 600cc, 800cc, and 1100cc canisters. When choosing the canister size, consider the amount of wound exudate and the therapy mode. If using the Instill mode, also consider the amount of instillation fluid and the frequency of instillation.

- Slide the canister into the back of the DUO NPWT Therapy Unit.
- Attach the canister by pushing the canister into place onto the DUO NPWT therapy unit. Make sure the canister is placed directly on the therapy unit. Do not twist or rotate the canister while inserting it

Changing the canister

- The canister can be changed under normal conditions or if the alarm is actively alerting.

Removing or changing the canister

Close the clamp on the tube to ensure that exudate does not leak from the tube.

Ensure the device is off.

To remove the canister, press the canister placement lock, canister will release.

To attach the canister, insert the canister according to the image on the back of the DUO device, "Canister Placement Symbol," shown in Figure 12 Step 2. Gently push the canister onto the device.

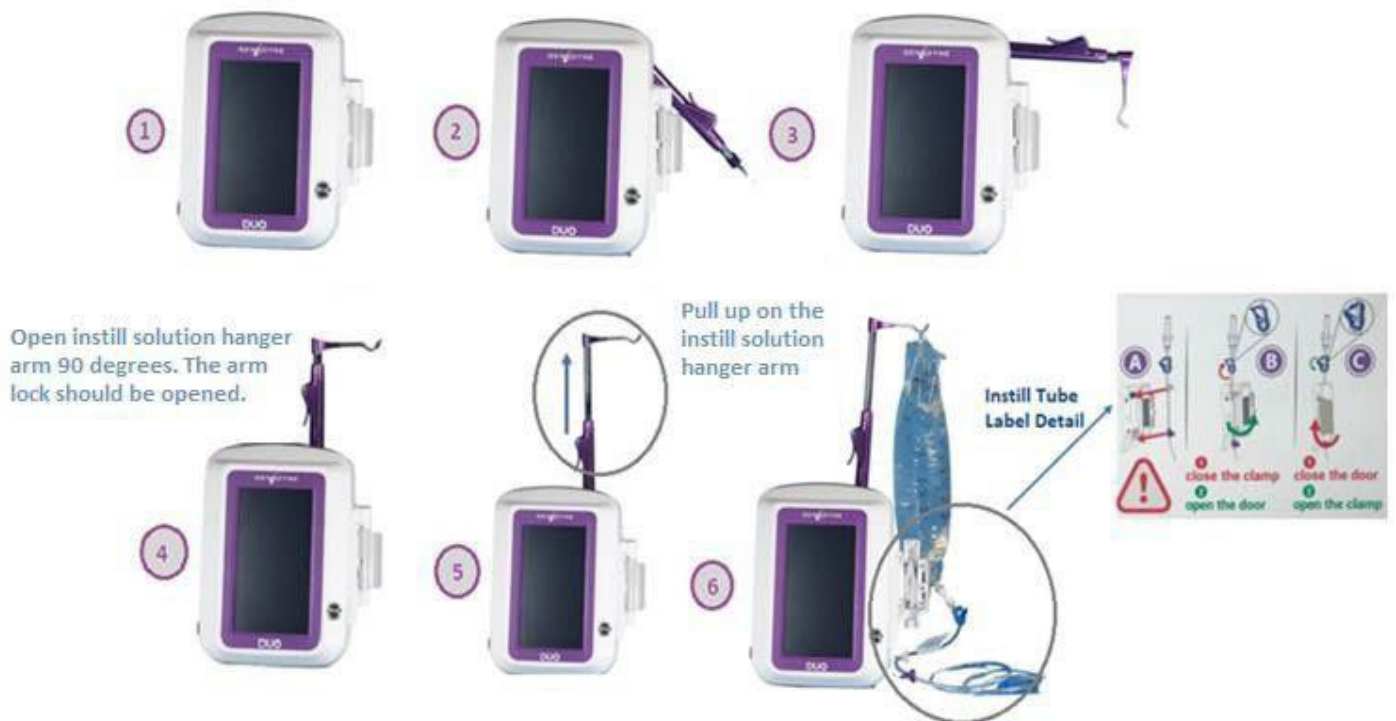

Figure 12 DUO Canister Attachment Steps

12.4.3 Preparation of Instill

The Instill Solution Hanger Arm is folded and located on the device's side. The opening steps for the solution Hanger Arm are shown in the pictures below. The connectors on the instill tube are placed according to the markings. In this case, the white connector stays on top, and the purple connector stays down. *Figure 13* describes the placement of the instill solution on the device. In addition, a descriptive label on the instill tube shows its attachment to the device.

Pre-treatment



Post-Treatment

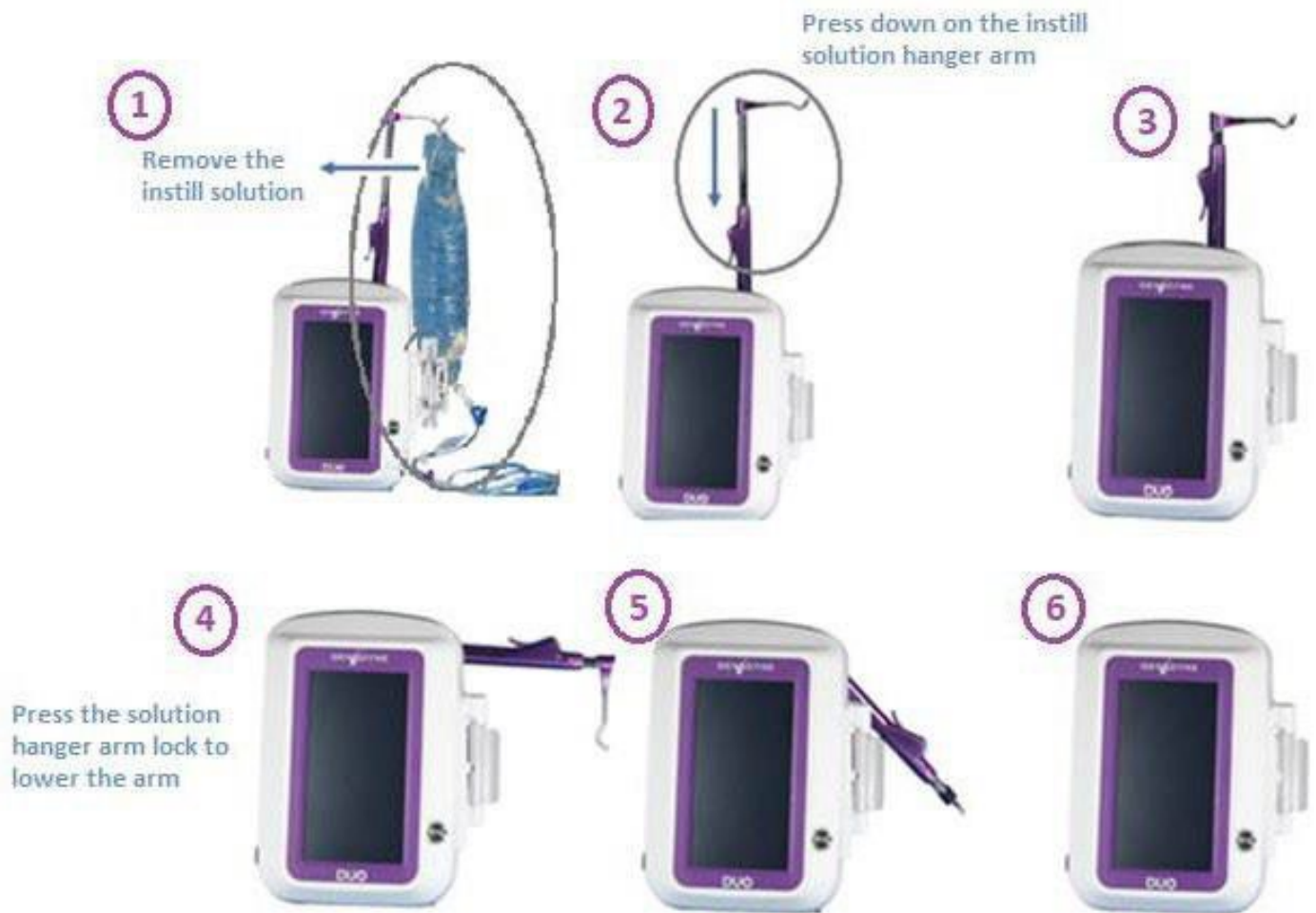

Figure 13 DUO Install Preparations Steps

Post-treatment

12.4.4 Power Connection

Plug the AC Power cord into the DC power supply.



Figure 14 DUO Device Power Supply

Plug the AC plug into an AC outlet.

Insert the connector into the power connector on the DUO NPWT.



Figure 15 Connecting the Power Supply to the Device

12.4.5 Using IV Pole Clamp

The IV pole clamp can be placed in a convenient position near the patient requiring treatment, making the treatment process more comfortable for the patient.



Figure 16 IV Pole Clamp

13. THERAPY MODES

The Genadyne DUO provides the user with 3 therapy modes.

1. Continuous Mode
2. Variable/Intermittent Mode
3. Instillation Mode

13.1 Continuous Mode

Continuous Mode ensures that the set Target Pressure level is applied to the wound continuously. Continuous mode is selected from the main menu of the device; details are given in *Figure 17* in detail.



13.1.1 Continuous Mode Settings

Intensity Setting: The intensity level determines the speed of the vacuum pumps. There are 3 Intensity Levels: HIGH, MEDIUM, and LOW. When the HIGH-intensity level is selected, the vacuum pump provides more airflow. Touch the Intensity screen and adjust the button in *Figure 18* to open the intensity setting screen.

Target Pressure Setting: The Target Pressure is the desired negative pressure value in mmHg. When therapy is started, the device increases the vacuum until it reaches the Target Pressure level. The actual pressure value is held as the Target Pressure during therapy. The Target Pressure can be selected between 25 and 200 mmHg. Touch the Target Pressure Level Screen in *Figure 18* to open the Target Pressure setting screen.

The steps for using the Continuous Mode selection are given below.

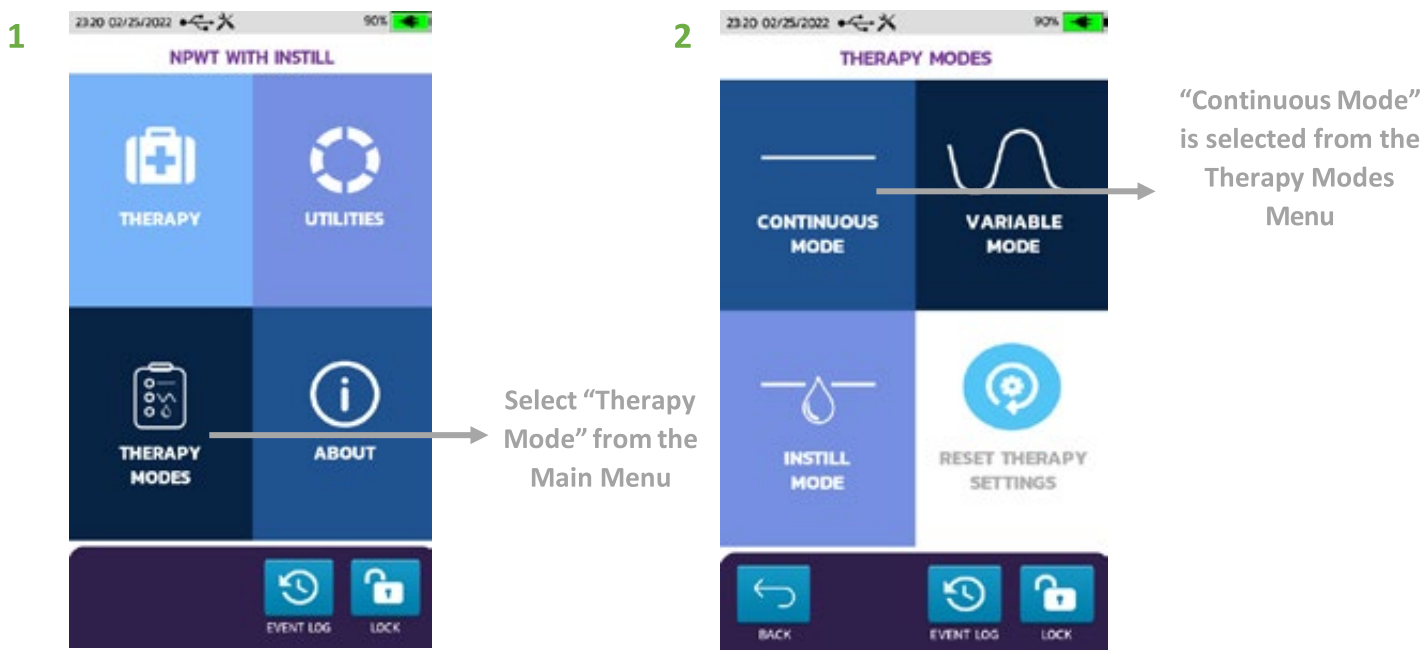

Figure 17 Continuous Mode Therapy Selected

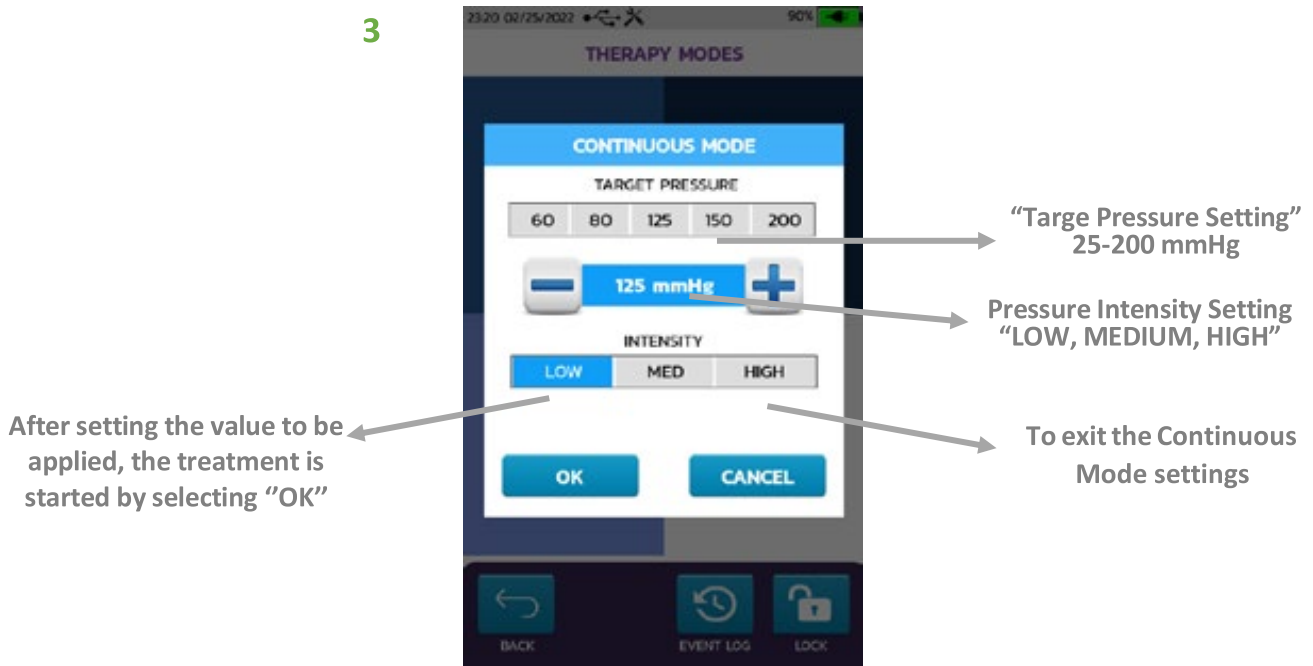

Figure 18 Setting Treatment Parameters of Continuous Mode

The Continuous Mode Screen during treatment after adjustment is given in Figure 19.

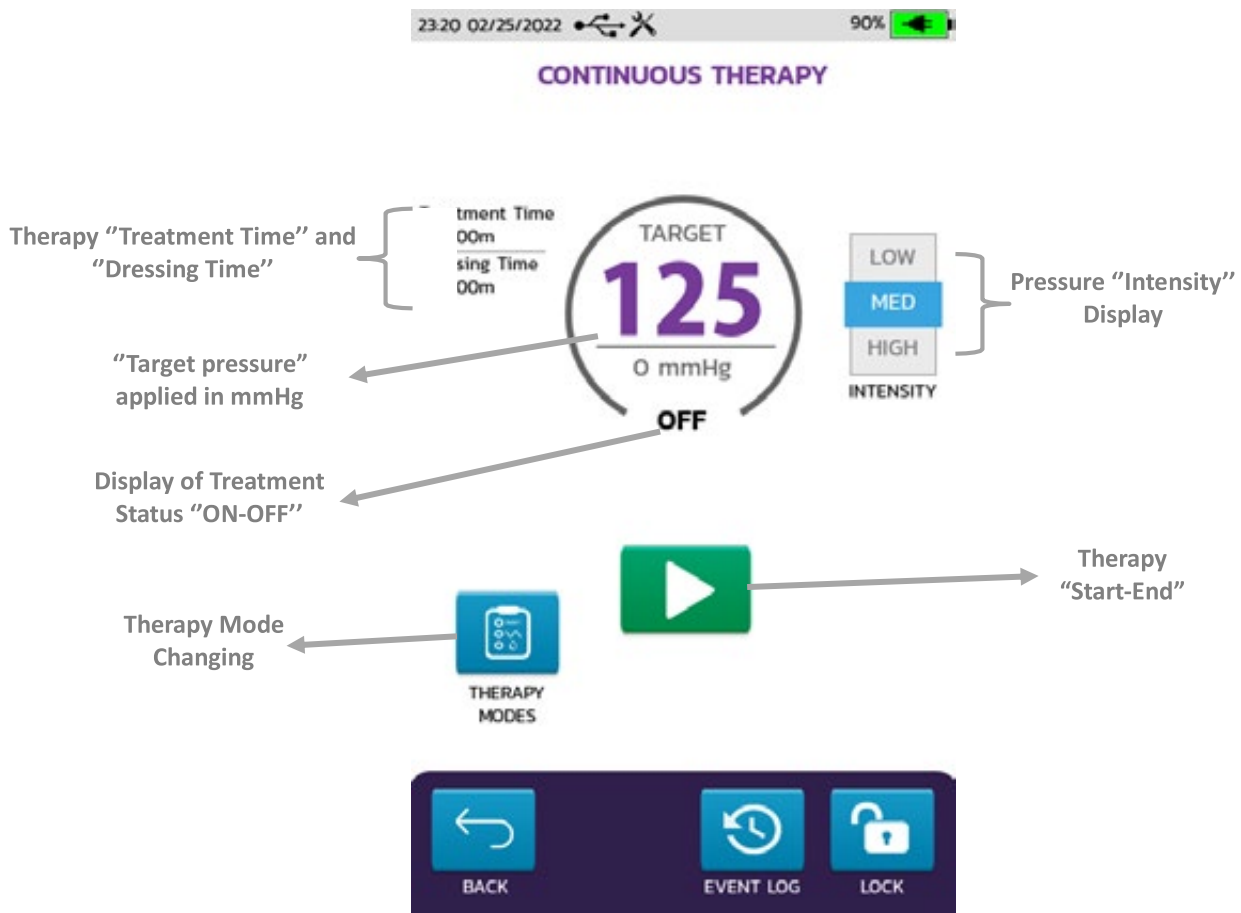

Figure 19 Continuous Mode Treatment Screen



When you touch target pressure, the target pressure setting menu opens.



Figure 20 Setting Parameters when the device operating screen

13.2 Variable/Intermittent Mode

Variable Mode is the application of the negative pressure values, in mmHg, determined by the clinician to be applied in sensitive wound beds at the specified times. *Figure 21* details how to select variable mode through the device's main menu.

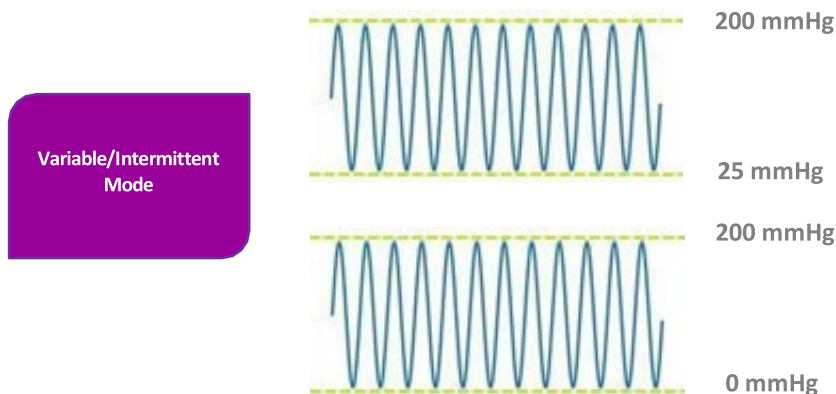

13.2.1 Variable Mode Settings

The steps for using the Variable Mode selection are given below.

Up Pressure: The *higher*-level pressure to be applied to the wound bed.

Up Time: The duration of application of the *higher* pressure applied to the wound bed.

Down Pressure: The lower-level pressure to be applied to the wound bed.

Down Time: The duration of application of the lower pressure applied to the wound bed.



Select "Therapy Mode" from the Main Menu

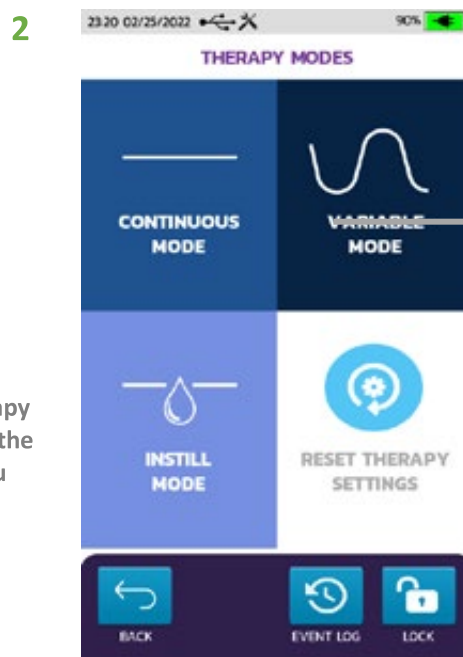

"Variable Mode" is selected from the Therapy Modes Menu

Figure 21 Variable Mode Therapy Selection

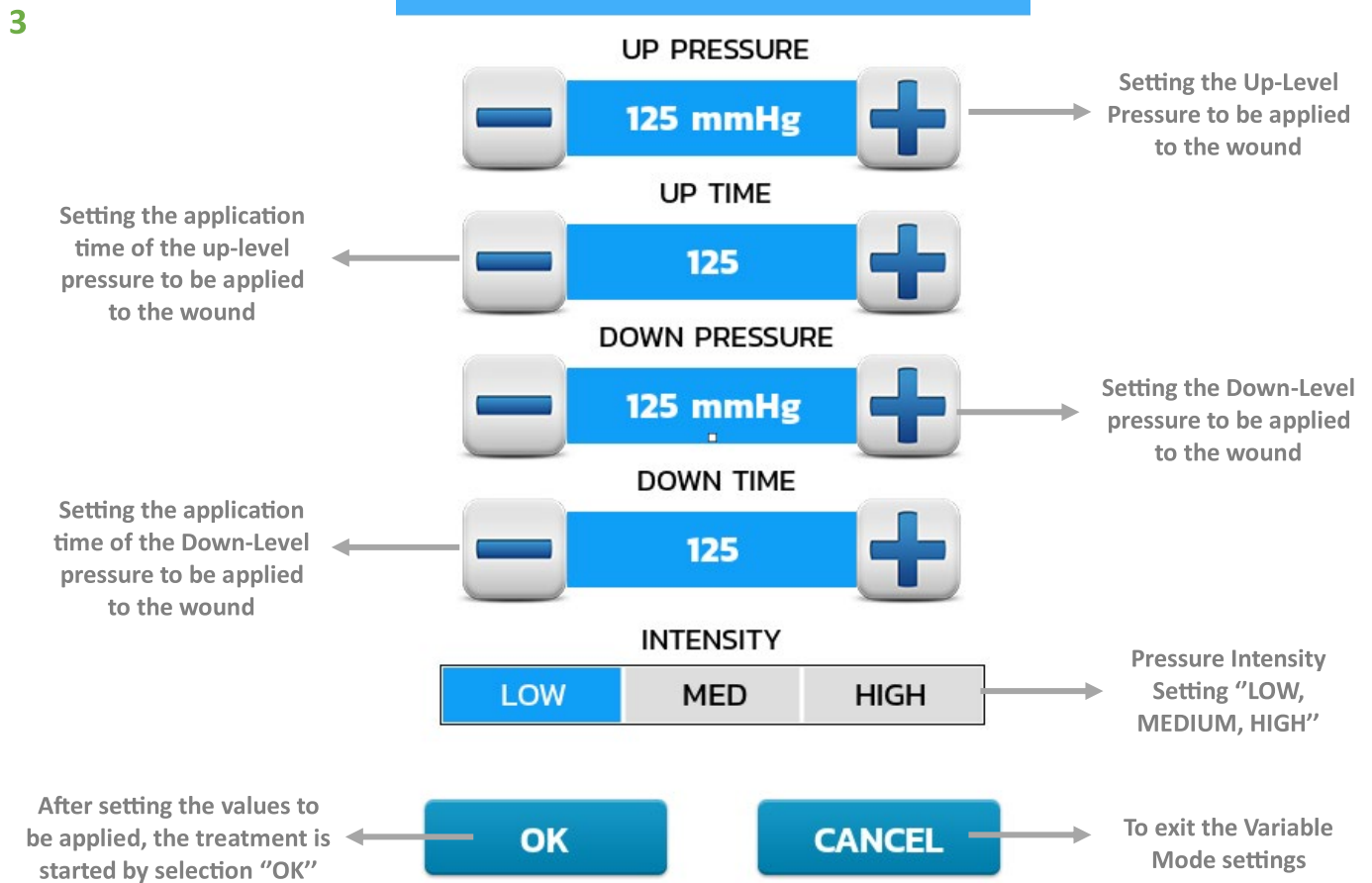

Figure 22 Setting Treatment Parameters of Variable Mode

The Variable Mode Screen during treatment after adjustment is given in *Figure 23*

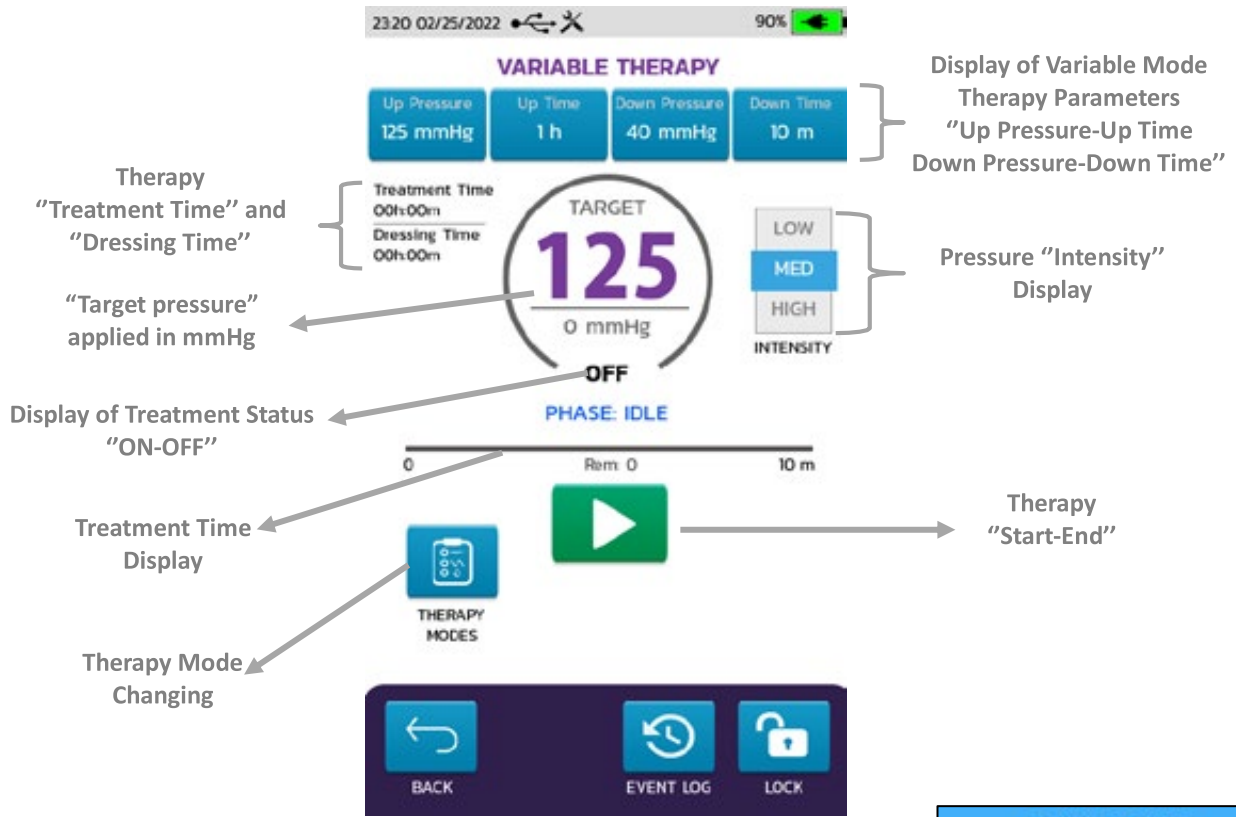

Figure 23 Variable Mode Therapy Screen

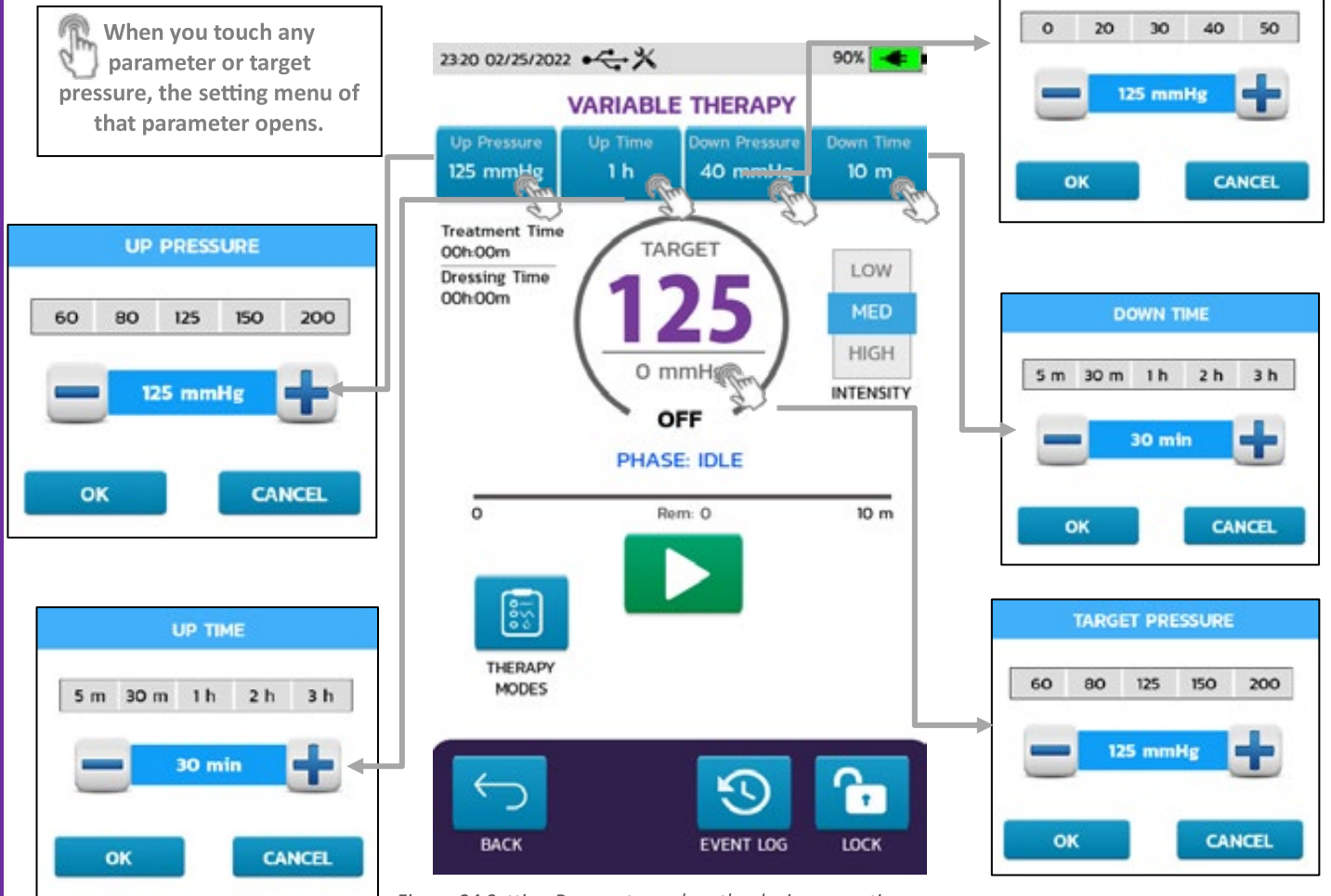

Figure 24 Setting Parameters when the device operating screen

13.3 Instill Mode

The instill mode consists of NPWT combined with the automatic, controlled delivery and removal of wound treatment solutions to and from the wound bed. It offers a more conducive dressing environment for wound bed healing, with adjustable target pressure, vacuum time, instill volume, and soaking time. *Figure 25* details the instill mode selection via the device's main menu.

With the adjustable target pressure, negative pressure in mmHg is applied to the wound.

Soak Time: the instill foam has a soaking phase after instilling liquid delivery. The instill delivery stops, allowing the liquid to spread in the wound.

Therapy Stages

The therapy phases may begin with instillation or vacuum, depending on the type of wound and the clinician's judgment.

When Vacuum Treatment is Started

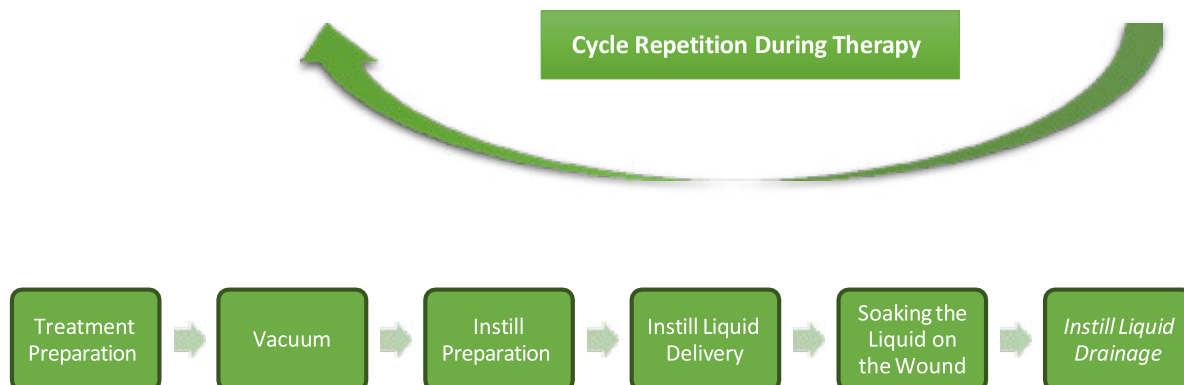

When Treatment is Started with Instill

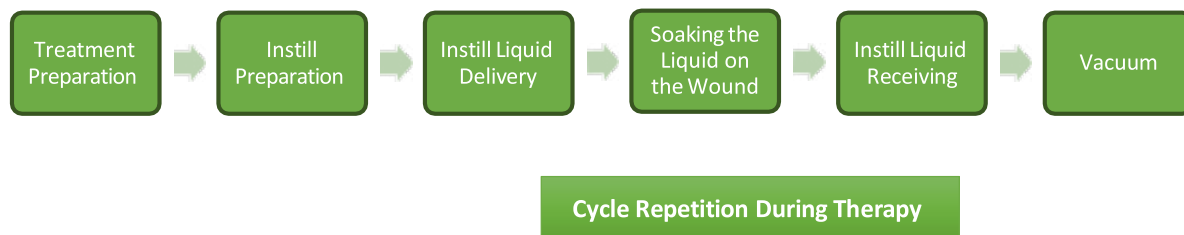

13.3.1 Instill Mode Setting

The steps for using the Instill Mode selection are given below.

Target Pressure: The negative pressure value in mmHg that is desired to be applied to the wound bed. When therapy starts, the device increases the vacuum until it reaches the Target Pressure level, and the actual pressure value is held as the Target Pressure during the therapy.

Vacuum Time: The duration of application of the determined target pressure to the wound bed.

Instill Volume: The volume of instill fluid to be applied to the wound bed.

Soaking Time: The residence time of the instill liquid applied to the wound bed.

Volumeter (Instill Assist): The Volumeter (Instill Assist) feature helps clinicians determine the optimal liquid volume needed to fill a wound. Once determined, this value is automatically set as the Instill Volume parameter for precise and consistent treatment.

Manual prime: This feature will allow the device to manually deliver instill fluid to the wound site.

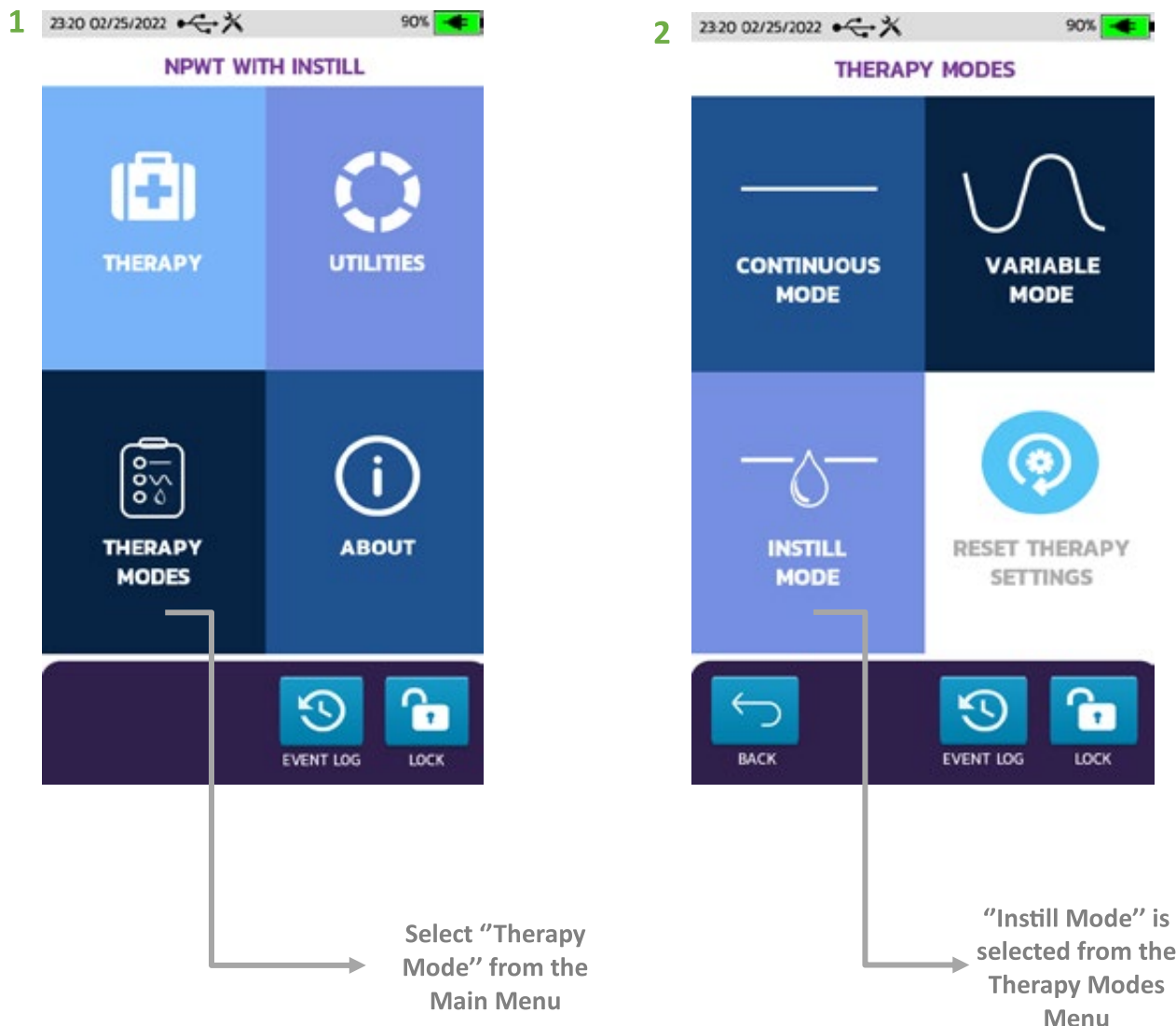

Figure 25 Instill Mode Treatment Selection

INSTILL MODE

TARGET PRESSURE

125 mmHg

PRESSURE TIME

1 m

SOAK TIME

1 m

INTENSITY

LOW MED HIGH

START PHASE

VACUUM INSTILL

1/2

NEXT CANCEL

Target Pressure Setting

Pressure Time Setting

Soak Time Setting

Intensity Setting

Start Phase Setting

Go to the next page to continue selecting the Instill Therapy settings.

To Exit the Instill Mode settings

INSTILL MODE

INSTILL VOLUME

5 20 50 100 250

10 ml

USE VOLUMETER

2/2

OK CANCEL

Instill Volume Setting

Volumeter Function (Instill Assist)

To Exit the Instill Mode settings

After Adjusting the value to be applied, the treatment is started by selection "OK"

Figure 26 Setting Treatment Parameters of Instill Mode

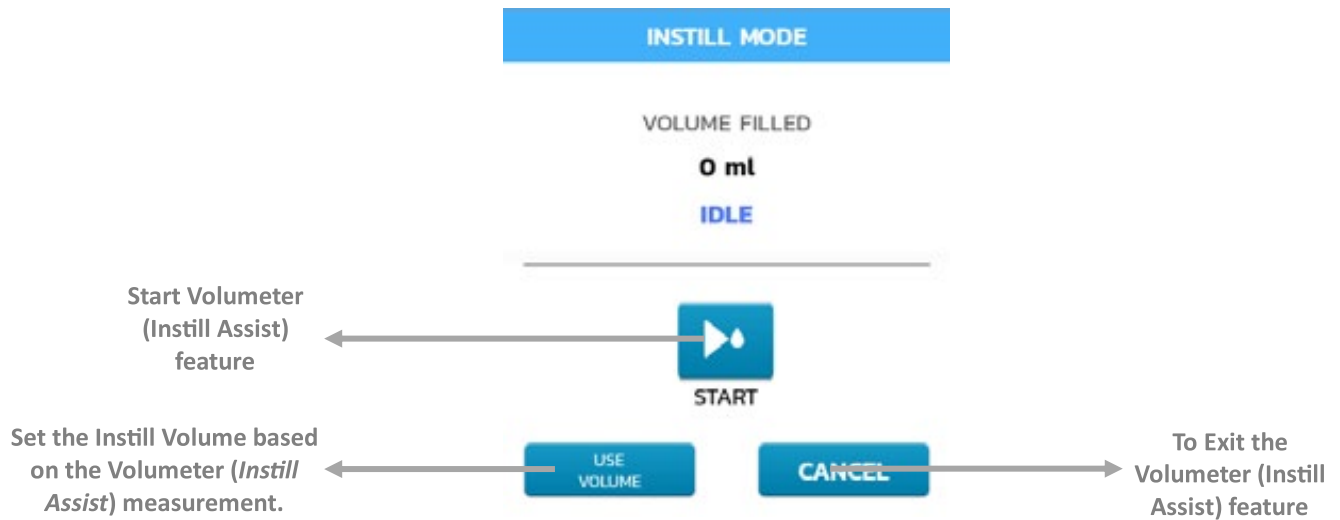

Figure 27 Volumeter (Instill Assist)

After the adjustment, the Instill Mode Screen is given in Figure 28 during the treatment.

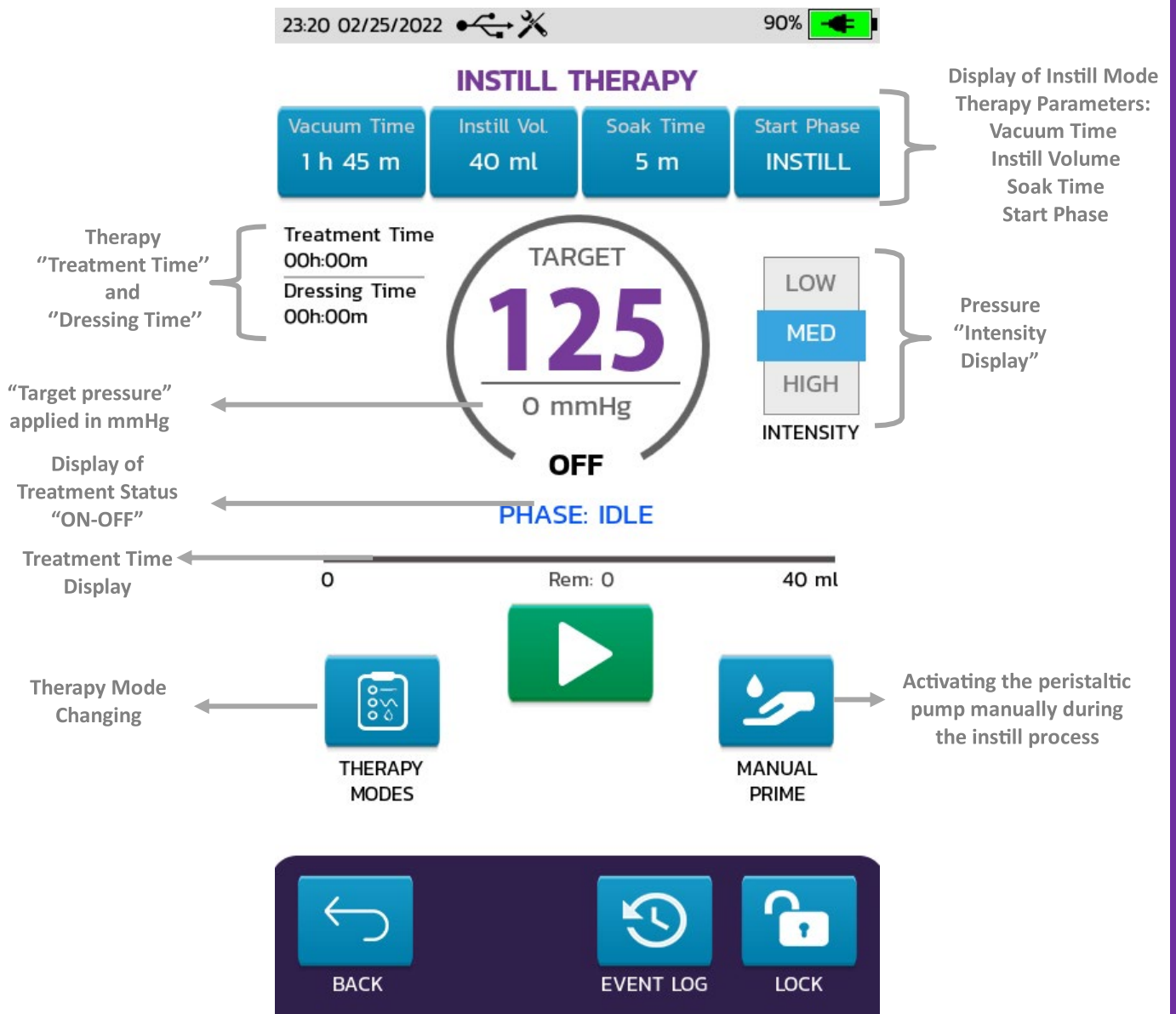

Figure 28 Instill Mode Treatment Screen

When you touch any parameter or target pressure, the setting menu of that parameter opens.



Figure 29 Setting Parameters when the device operating screen

14. OTHER SCREENINGS AND SETTINGS

Time / Date Display: Shows current time and date.

Battery Level: This displays the device's remaining battery percentage with a colored icon. When the device is plugged in, the battery icon is accompanied by a lightning symbol.

Lock: Activates the device's locked mode, helping to prevent any unwanted interference or changes to settings during therapy. To unlock, press and hold the "lock" symbol.

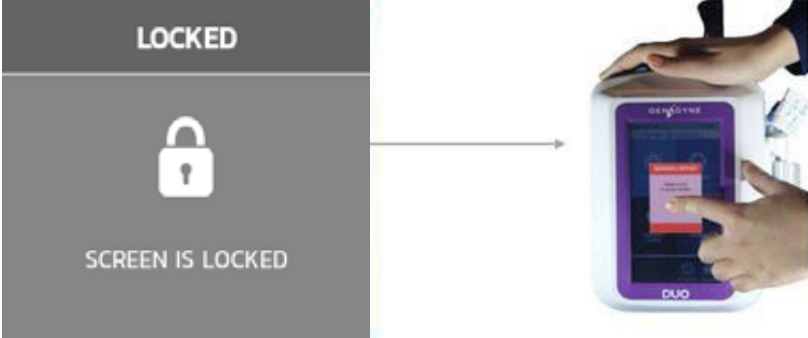

Figure 30 Device lock and unlock

Event Log: Provides logging information about significant events that occur during device operations. Two separate history records are stored in the device's memory. A total of 2400 device event logs are retained.

- **Device History:** Displays the on/off status, therapy modes, settings, and any changes made since activation. It also records the start, pause, and end times and dates for therapy modes. A total of 1,200 pieces of device history data are stored.
- **Alarm History:** This section displays the record of all alarms generated by the device since it began operation. A total of 1,200 entries are maintained in the alarm history.

Figure 32 provides detailed information.

In addition to active therapy modes and settings, the device offers various information displays and logs, as shown in Figure 31 below.



Figure 31 Active Therapy Modes Other Selections

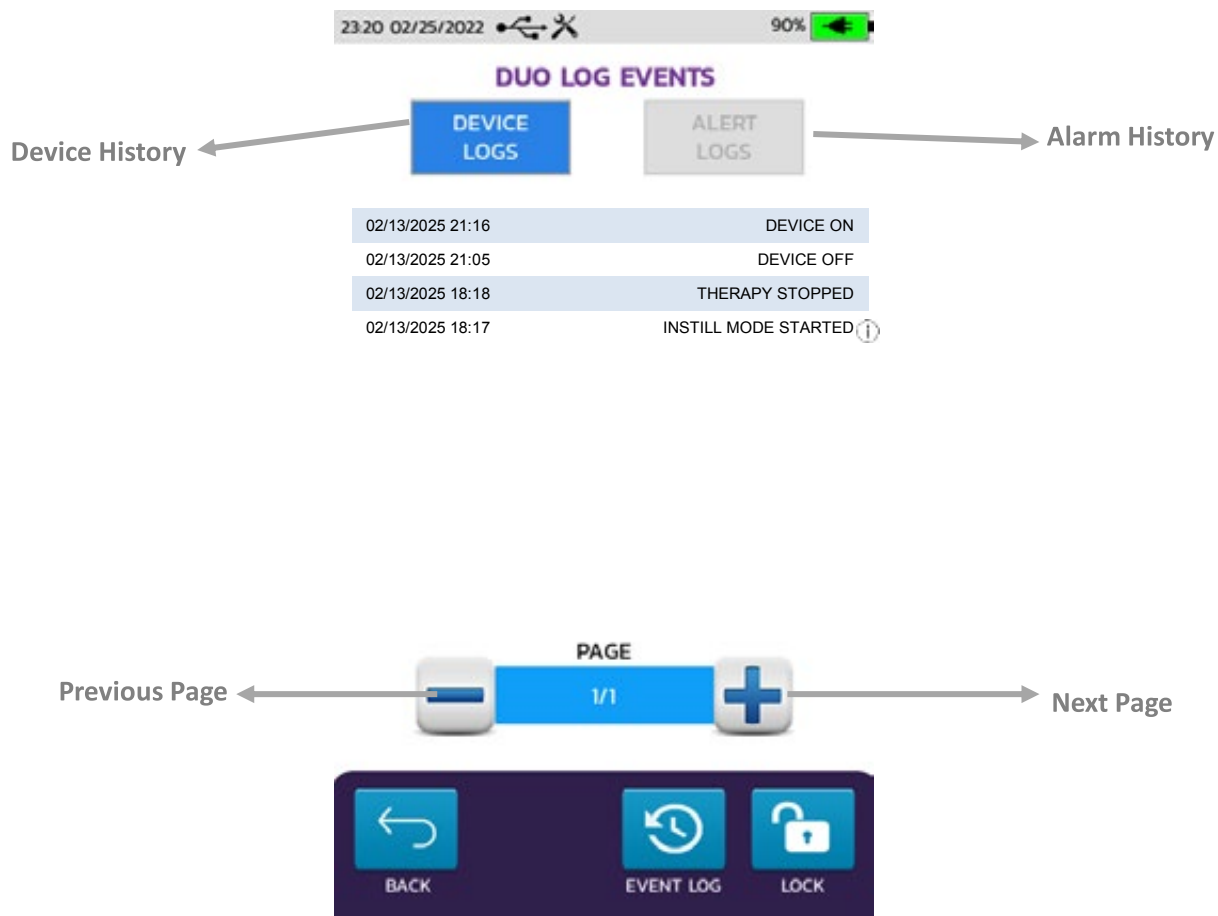

Figure 32 DUO Device History Records

14.1 Utilities

After selecting the Utilities tab from the main menu, the Adjustments tab appears, where we will make changes to the device. Details are in Figure 33.



Figure 33 DUO Device Utilities Screen

Regional Settings: Regional settings enable users to select device language, adjust volume units, format dates, and set GMT.

Language Setting: This feature enables the device to identify the user's language during treatment. The device supports *twelve languages*: Turkish, English, Spanish, Ukrainian, French, Italian, German, Swedish, Greek, Finnish, Dutch, Polish, and Portuguese.

Volume Unit Setting: This specifies the volume measurement of fluid to be administered to the wound bed during the device's instillation mode. The device provides two volume units: "ml" and "cc."

Date Format: This allows you to determine the order of the day, month, and year of the date that will be displayed on the device. The device has two Date Formats: month/day/year (mm/dd/yyyy) and day.month.year (dd.mm.yyyy).

GMT Setting: Allows for the determination of Greenwich Mean Time on the device.

Show Treatment Time: Displays the treatment duration on the active treatment screen.

Details are given in *Figure 34*.

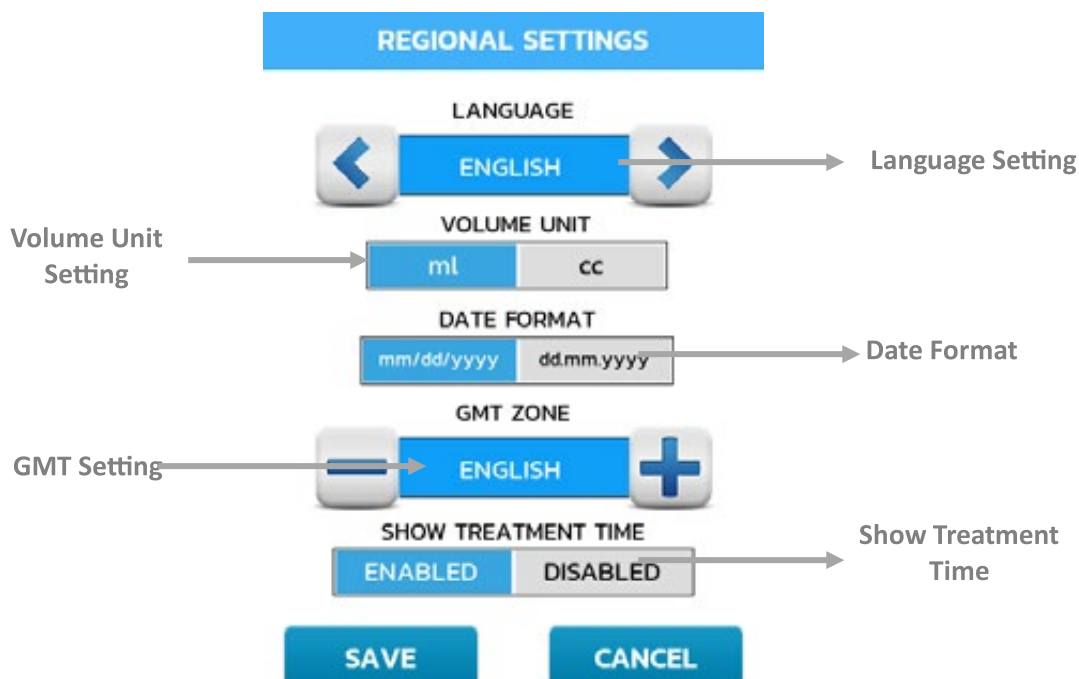

Figure 34 DUO Regional Settings

Brightness and Sound Adjustment: The brightness settings allow users to adjust the brightness of the screen, the Auto Dim Timer, and key sound settings. Adjustment details are shown in *Figure 34*.

Brightness Level: The device allows users to adjust the screen brightness.

Auto Dim Timer: It enables the screen to dim after the designated time during the treatment.

Button Sound: It allows the key tone to be toggled on and off during operations conducted on the user screen while using the device.

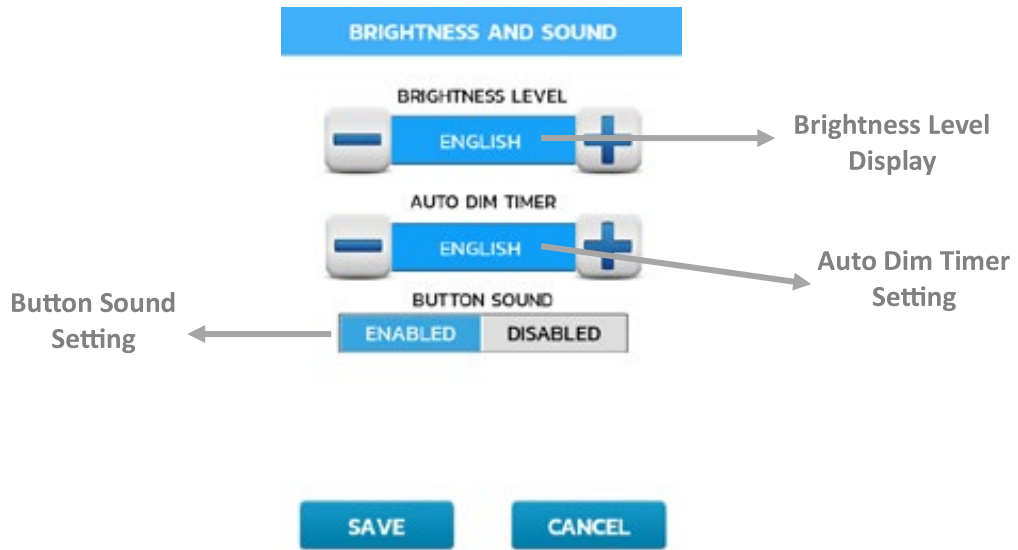

Figure 35 DUO Brightness and Sound Settings

Alarm: Displays the alarm levels of the device.

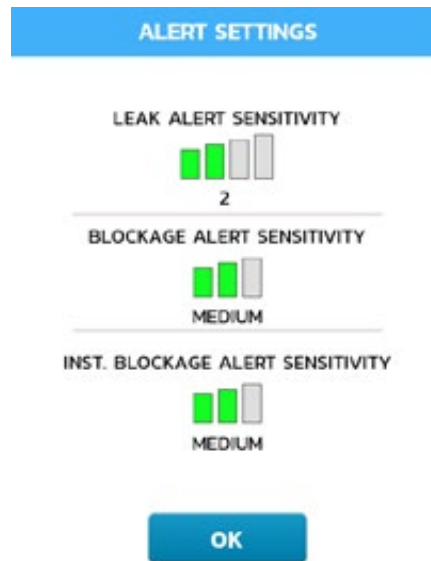

Figure 36 Alarm Settings Screen

Note: Press and hold the Alerts Settings button for 7 seconds to adjust alert sensitivity and clear event logs (see Figure 37).

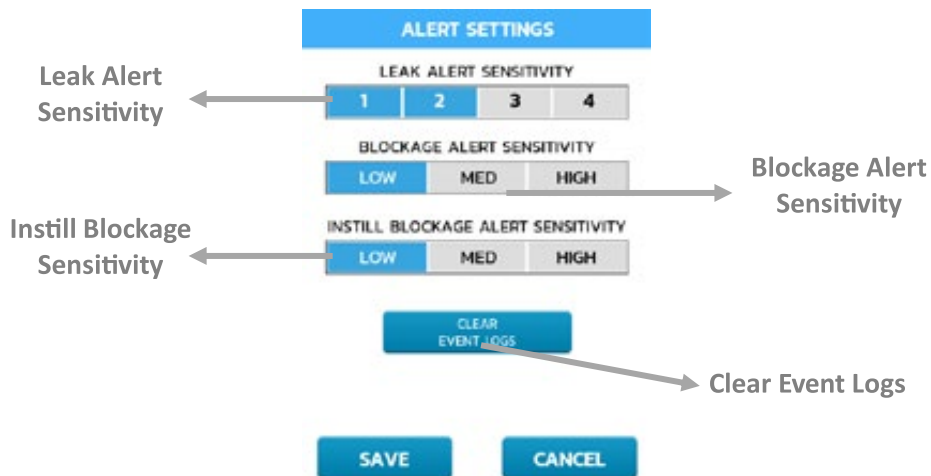

Figure 37 Alert Sensitivity

Service: This contains the device's service settings. Only authorized personnel can access these settings. *Figure 38* shows the warning screen displayed when trying to log in.

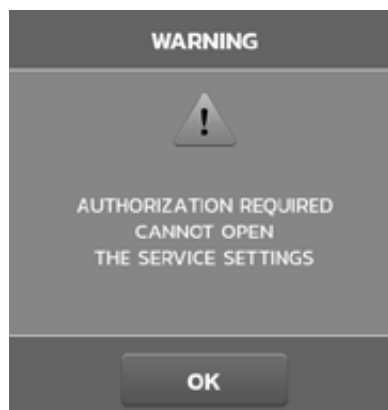

Figure 38 Service Setting Screen

Information About the Device

Users can view device and system versions, as well as support contact information, by selecting the "Info" tab from the main menu screen. A detailed image is provided in *Figure 39*.

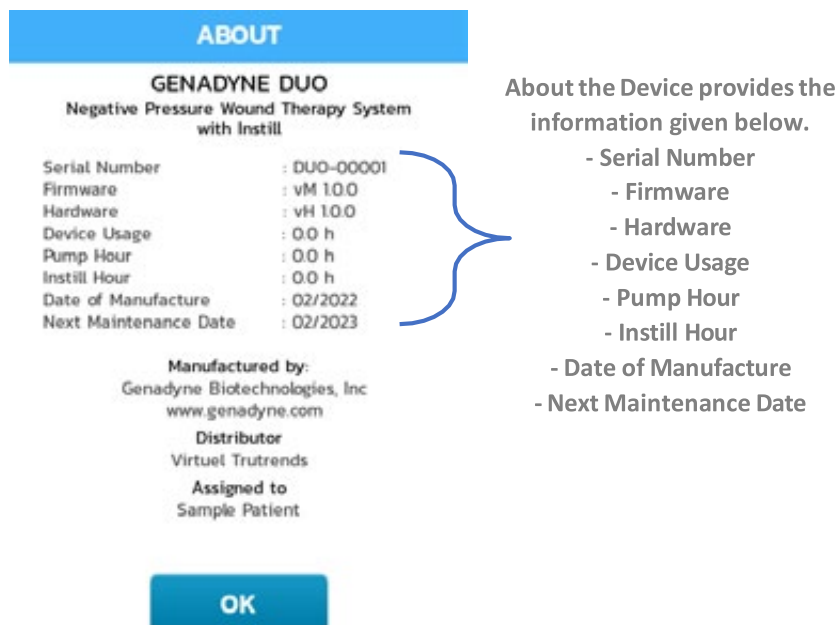

Figure 39 DUO Information Screen

15. ALARMS

The device includes an alarm system that alerts the user in case of any disruption during its use. The alarm system provides an audible warning and displays the reason for the alarm in a message box on the main screen.

To prevent confusion in the treatment process, it is recommended that the alarm history be cleared before using the unit on each new patient.

Leakage Alarm: The alarm is activated when a negative pressure leak is detected in the dressing or negative pressure application line parts during treatment. A repeating audible tone accompanies the alarm.

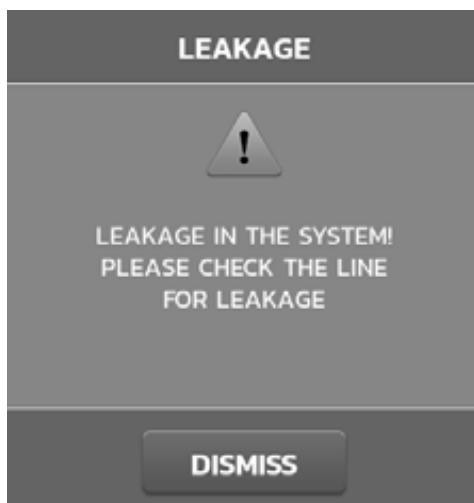

Figure 40 Leak Alarm Screen

Canister Full Alarm: This alarm activates when the canister is full and needs to be replaced. A repeating audible tone accompanies the alarm.

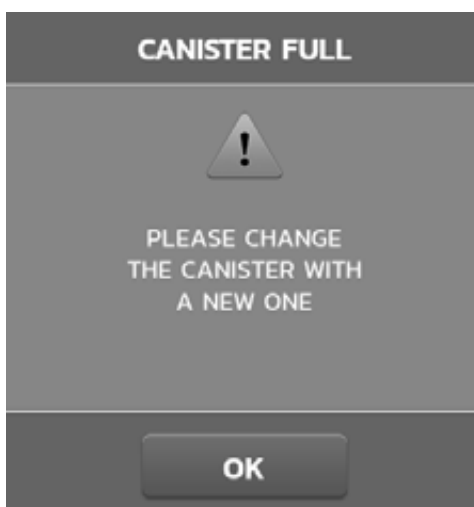

Figure 41 Canister Full Alarm Screen

Blockage Alarm: The alarm activates when a blockage occurs in the vacuum line and is accompanied by a repeating audible tone.



Figure 42 Blockage Alarm Screen

Instill Blocking Alarm: If the instill tube is blocked or the hose is broken, the alarm is activated. A repeating audible tone accompanies the alarm.



Figure 43 Instill Blockage Alarm Screen

Battery Low: An alarm is activated when the battery level is low to ensure uninterrupted therapy. The alarm is activated when the battery is below 20%. A repeating audible tone accompanies the alarm.

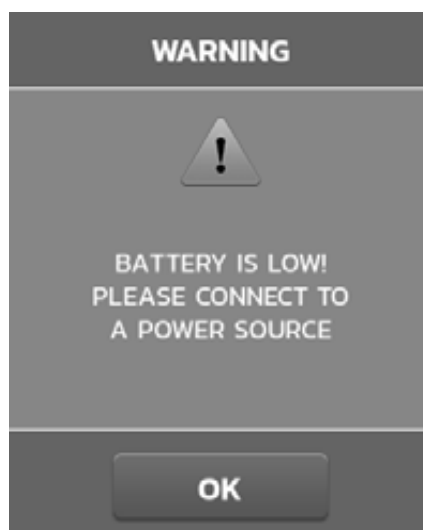

Figure 44 Low Battery Alarm Screen

Solution Bag Empty Alarm: While the device is operating in instill therapy mode, the alarm will activate when there is no liquid remaining in the Instill solution bag/bottle. A repeating audible tone accompanies the alarm.

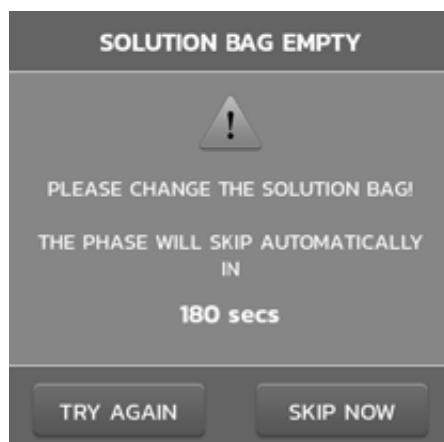

Figure 45 Solution Bag Empty Alarm Screen

Instill Door Open: If the device's instill door is open during treatment, the alarm is activated. A repeating audible tone accompanies the alarm.



Figure 46 Instill Door Open Alarm Screen

Instill Door Closed: The alarm occurs in instill therapy mode if the clamp on the instill tube is closed while the instill door is closed. A repeating audible tone accompanies the alarm.

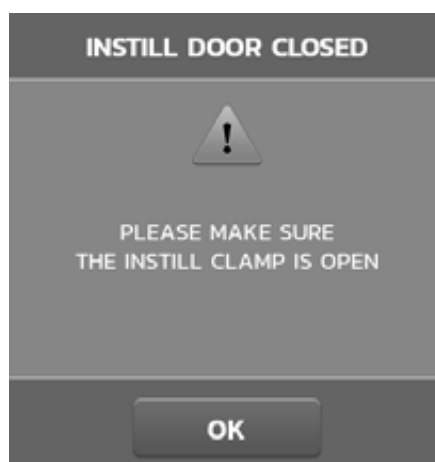

Figure 47 Instill Door Closed Alarm Screen

16. MAINTENANCE, SERVICE, and SETUP MENU

The Genadyne DUO NPWT should be scheduled for maintenance every year or 6,000 hours, whichever comes first. The unit will automatically signal with an icon on the screen to alert the end user. The mandatory Scheduled Diagnostic Maintenance includes a full inspection and diagnostics of the unit: replacement of internal tubing and battery if necessary, replacement of double O-rings, replacement of odor patches, and cleaning of both the inside and outside of the unit. This maintenance ensures proper ongoing performance of the unit, as well as maintaining the indicated battery run time. The Scheduled Diagnostic Maintenance is conducted at Genadyne Headquarters in New York. Alternatively, Genadyne provides training to any dealer or hospital that wishes to offer service on-site.

Failure to comply will void the warranty. A Visual Preventative Maintenance is also recommended in between patients to detect any possible issues before returning the device to the field. This consists of opening the back of the unit and doing an inspection of the internal muffler and filter system.

Cleaning



Do not use solvents or abrasives



Dry with a separate soft cloth.

Do not immerse any part of the DUO in fluid or use an unnecessarily wet cloth.



Ensure that the Genadyne DUO and its power supply are not connected to AC power when using cleaning fluids of any nature.

Adherence to facility directives concerning hygiene is of prime importance. When cleaning the DUO, only use a low-level diluted form of disinfectant (water or ethyl alcohol 70%) or cleaning agents. Use a damp cloth to clean the pump.

The Genadyne Duo Device should be cleaned carefully. During the cleaning process, no liquid should enter the power unit. If liquid does, it may cause malfunction and damage to its mechanics.

The following recommendations should be considered when cleaning and disinfecting the Genadyne Duo Device.

- To prevent infection and contact with blood and body fluids, please use medical-grade gloves.
- Clean & remove all visible soil or body fluids from the therapy units before the disinfection process.
- For cleaning purposes, please use hospital-grade cleaners and disinfectants.
- Please do not immerse or saturate the therapy unit with fluids to prevent damage to its electronic components.
- Please do not use alcohol-based solutions around the touchscreen and power switches, as this may cause equipment malfunction. Alcohol can easily leak into the screen and damage device functions.

Please contact your distributor if any liquids penetrate the device.

Device initialization and service updates are achieved through the DUO management PC software (*DUO Connect*). To initiate the process, the device needs to be connected to the PC through a USB cable. Refer to *Figure 48* for the management software view below. Only Genadyne/Trained personnel can perform this operation.

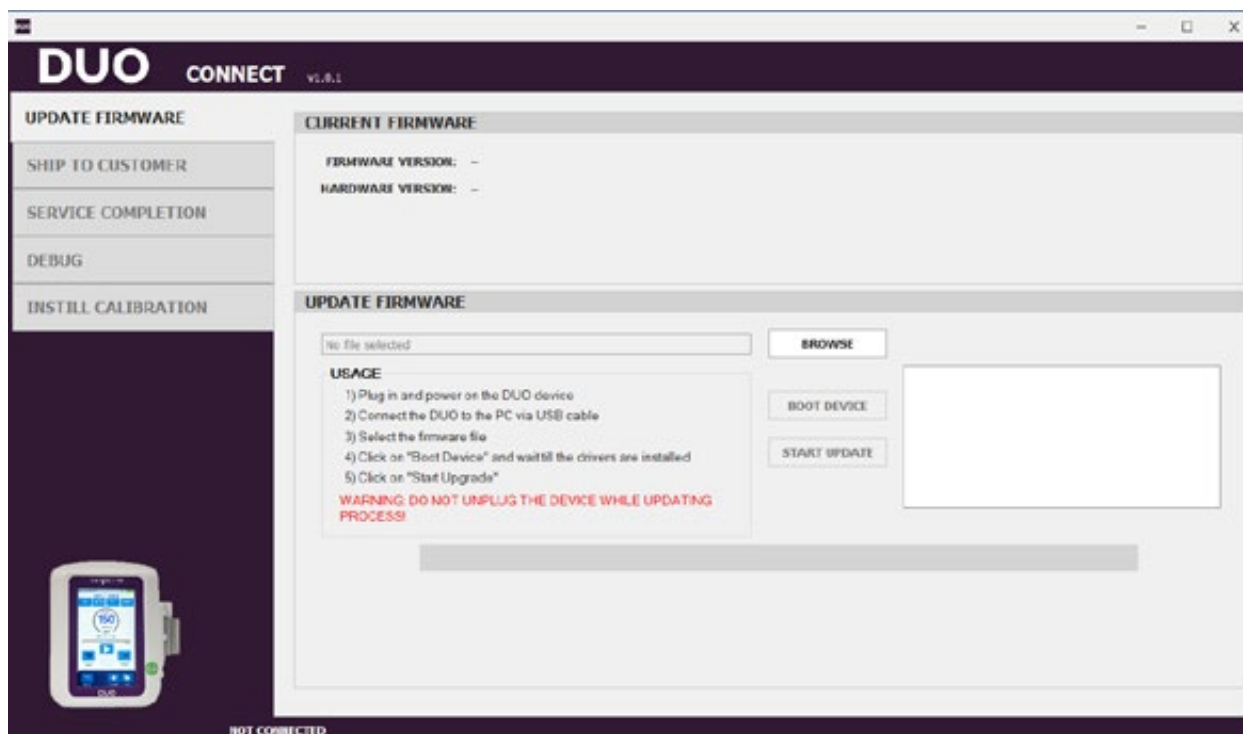

Figure 48 DUO Management Software (DUO Connect)

17. BATTERY POWER









ONLY USE THE POWER ADAPTER INCLUDED IN THE BOX. DO NOT USE AN UNKNOWN POWER ADAPTER.

The DUO can operate on batteries or while connected to the power adapter. Please note that each time the power adapter is connected to the machine, it charges the battery. However, while the machine is plugged in, it does not affect or interfere with the therapy; the DUO machine will continue to function normally.

18. COMPONENTS AND ACCESSORIES USED WITH THE DUO SYSTEM

The DUO Negative Pressure Wound Therapy System should be used with the following components and accessories.

Component/Accessory Name and Description	Image
<p>DUO Foam Dressing Kits Thick Small/Medium/Large</p>	
<p>DUO Foam Dressing Kits Thin Small/Medium/Large/ Extra Large</p>	
<p>DUO Abdominal Dressing Kit</p>	
<p>DUO Bridge Foam Dressing Kit</p>	
<p>DUO PVA Foam Dressing Kits Small/Medium/Large</p>	
<p>DUO Silver Foam Dressing Kits Small/Medium/Large</p>	
<p>DUO Instill Therapy Foam Dressing Kits Small/ Medium/ Large</p>	
<p>DUO Perforated Instill Foam Dressing Kits</p>	
<p>DUO Port (Double Lumen)</p>	
<p>DUO Port (Triple Lumen)</p>	
<p>Duo Instill Tubing</p>	

Transparent Film



DUO Canister 600-800-1100 cc



19. DRESSING APPLICATION

Step 1: Select the appropriate size of DUO from the kit for the wound.

Step 2: Clean the wound according to the facility protocol. Protect wound edges with the drape.

Step 3: Cut the sponge to fit the wound. Place the sponge on the wound bed. Do not cut the sponge over the wound.

Step 4: Cover the foam with transparent film. Peel layers 1, 2 and 3 remove the handlers.

Step 5: Cut a hole on the drape in the middle of the foam approximately 1" in diameter. Remove the paper backing (number 1) from the port pad. Place over the hole. Peel number 2. Remove handlers.

Step 6: Connect the port pad tubing to the canister tubing. Ensure all clamps are unclamped at this time.

Note: If Instill Therapy is applied to the wound, the port tube inlets should be positioned opposite to the direction of gravity when applying it to the wound. The application position of the port is illustrated below.

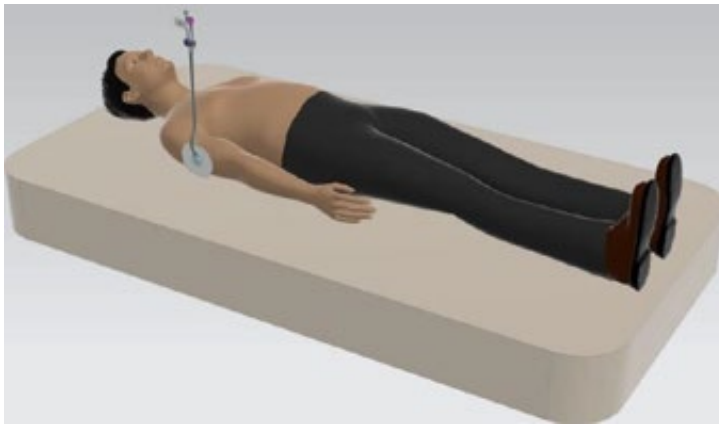

Step 7: Initiate therapy at the prescribed pressure by turning the machine on.

Step 8: Foam will collapse down, and target pressure will be achieved.

Step 9: Before redressing the wound, ensure all wound filler material has been removed. If foam dressing adheres to the wound, apply saline and let it set for 15–30 minutes before gently removing the foam. Appropriately discard used wound dressings, observing your institution's protocol for medical waste handling.



Figure 49 Device Application Model

20. DUO CLINICAL GUIDELINES

20.1 DUO Pressure Settings

The settings in this guideline are general recommendations. Adjustments to the pressure settings may vary depending on the individual patient's needs, physician orders or an expert clinician's guidance. The default setting is 125 mmHg, but the setting can be individualized to the patient's needs.

Consider changing the pressure setting up by 25 mmHg for the following conditions:

- Excessive drainage, Large wound volume

Consider changing the pressure down by 25mmHg for the following conditions:

- Extreme age, compromised nutrition, risk of excessive bleeding, circulatory compromise, pain or discomfort not relieved by appropriate analgesia, periwound or wound bed ecchymosis.

Recommended Therapy Settings

Wound Characteristics	Continuous	Variable	Instillation
Difficult dressing application	✓	✓	✓
Flaps	✓	✓	✓
Highly exudating	✓		✓
Grafts	✓	✓	✓
Painful Wounds	✓	✓	✓
Tunnels or undermining	✓	✓	✓
Unstable structures	✓		✓
Minimally exudating	✓	✓	✓
Large wounds	✓	✓	✓
Small wounds	✓	✓	✓
Stalled progress	✓	✓	✓
Infected Wounds	✓	✓	✓

21. RETURNING THE DEVICE

For any returns or rental returns, the device must be cleaned according to the steps in the cleaning section of this manual before being returned to your active response.

All used canisters must be disposed of. The disposal of used canisters should follow facility protocols or local ordinances.

The device will also need to be returned to the original packaging.

Disposing of the device

The device contains batteries. Do not throw them in the trash. Instead, return them to Genadyne or follow local battery disposal procedures.

22. LIMITED WARRANTY

Genadyne Biotechnologies warrants its products listed below for one year from the date of purchase. This warranty does not cover damage or breakdown of Genadyne units resulting from misuse or improper handling.

The company will repair the system outside of the warranty coverage and shall bill the customer for parts and labor. Items sent in for repair outside of the warranty period that are paid shall have a limited 90-day warranty to continue once the repaired product is shipped back to the customer. The company also reserves the right to revise the warranty policy from time to time and to issue different warranty policies for different products. This warranty shall supersede and replace all warranties of merchantability and fitness applicable to the fullest extent allowed under the laws of the State of New York.

C = Continuous V/IT = Variable Intermittent I = Instillation
For further information please contact your local Genadyne
Representative at 1-888-787-2811

23. TECHNICAL SPECIFICATIONS

Vacuum Pump

Service Life	1 Year – 6000 hours
Motor type	Brushless Motor
Continuous Mode	Min Vacuum 25mmHg; Max Vacuum 200mmHg
Variable Mode	Min Vacuum 0mmHg; Max Vacuum 200mmHg
Suction Capacity	~6 Liters per Minute
Instill Capacity	~6 mL per Minute

Dimensions and Weight

Dimension	7.03" (L) x 9.57" (W) x 6.61" (H) (178.5 mm x 243 mm x 168 mm)
Weight	5,73 lbs (2,6 kg)
Expected Service Life	1 year

Electrical Requirement

Power	19 VDC, 3.43A 65W (Max), 24 VDC (Max)
Battery Model	NCR18650B
Battery Type	Li-Ion Rechargeable Battery (4 cell)
Recharge Time	~ 2.5 Hours
Safety	EN ISO 60601-1, EN ISO 60601-2, CE Mark (LVD, EMC)

Environmental Conditions

Operating Conditions	18°C - 34°C, 65°F - 93°F
Relative Humidity	10% - 95% RH

Storage and Shipping Conditions

Ambient Temperature	0°F - 95°F, -18°C - 35°C
Relative Humidity	0% - 75 %
Battery Service Life	Battery service life is 1 year. When the battery is Fully charged (Please charge up to 100% before using the battery).

Patient Protection

- Class II per EN60601-1
- Applied part Type B per EN60601-1

Compliance

- EN 60601-1
- EN 60601-1-2
- EN/ISO 14791
- EN/ISO 10993
- EN/ISO 11135
- EN/ISO 11737-1:2006

24. ELECTROMAGNETIC COMPATIBILITY

Guidance and Manufacturer's Declaration – Electromagnetic Emissions		
The Genadyne DUO NPWT is intended for use in the electromagnetic environment specified below. The customer or the user of the Genadyne DUO NPWT should assure that it is used in such an environment.		
Emission Test	Compliance	Electromagnetic Environment - Guidance
RF Emissions CISPR 11	Group 1	The Genadyne DUO NPWT does not intentionally generate any RF energy. Its parasitic emissions are kept to minimum via circuit design therefore the RF emissions are very low and are not likely to cause any interference in nearby electronic equipment.
RF Emissions CISPR 11	Class B	Genadyne DUO NPWT is suitable for use in all establishments including domestic establishments and those directly connected to the public low-voltage power supply network that supplies buildings used for domestic purposes.
Harmonic Emissions IEC 61000-3-2	Class A	
Voltage Fluctuations/Flicker Emissions IEC 61000-3-3	Compliant	

The Genadyne DUO NPWT is intended for use in the electromagnetic environment specified below. The customer or the user of the Genadyne DUO NPWT should assure that it is used in such an environment.

Immunity Test	IEC 60601 Test level	Compliance Level	Electromagnetic Environment – Guidance
Electrostatic discharge (ESD) IEC 61000-4-2	Contact Discharge (Direct Application) 8 kV	PASS	Floors should be wood, concrete or ceramic tile. If floors are covered with synthetic material, the relative humidity should be at least 41%.
	Air Discharge (Direct Application) 2 kV, 4 kV, 8 kV, 15 kV	PASS	
	Horizontal Coupling Plane (indirect Application) 8 kV	PASS	
	Vertical Coupling Plane (indirect Application) 8 kV	PASS	
Electrical fast transient / burst TS EN 61000-4-4, EN 61000-4-4	Test Voltage: Power Line 2 kV Impulse Frequency & Wave Shape 100 kHz 5/50ns	Below maximum permissible limit	Mains power quality should be that of a typical commercial or hospital environment.

Surge IEC 61000-4-5	Test Voltage: 0,5 – 1 – 2 Impulse Characteristic: 1.2µs/50µs Coupling Method: L+N, L+PE, N+PE, LN+PE Polarity: P&N Phase Angle: 0-90-180- 270(degree)	Acceptable Performance	Mains power quality should be that of a typical commercial or hospital environment.
Voltage dips, short interruptions and voltage variations on power supply input lines IEC 61000-4-11	< 5% U _T (>95 % dip in U _T) for 0.5 cycle 40% U _T (60% dip in U _T) for 5 cycles 70% U _T (30% dip in U _T) for 25 cycles <5% U _T (100% interruption per 5 sec)	Acceptable Performance	Mains power quality should be that of a typical commercial or hospital environment. If the user of the device requires continued operation during power mains interruptions, it is recommended that the device be powered from an uninterruptable power supply or battery.
Power frequency (50/60 Hz) magnetic field IEC 61000-4-8	30 A/m	Compliant	Power frequency magnetic fields should be at levels characteristics of hospital environment
Immunity Test		IEC 60601 Test Level	Compliance Level
Conducted RF IEC 61000-4-6 Radiated RF IEC 61000-4-3	Vrms 50 MHz to 54 MHz 10.0 V/m 80 MHz to 2700 MHz		Compliant 10.0 V/m Interference may occur in the vicinity of equipment marked with the following symbol: 

Not 1: At 80 MHz and 800 MHz, the higher frequency range applies.

Not 2: These guidelines may not apply in all situations. Electromagnetic propagation is affected by absorption and reflection from structures, objects and people.

The Genadyne DUO NPWT is intended for use in an electromagnetic environment in which radiated RF disturbances are controlled. The customer or the user of the Genadyne DUO NPWT can help prevent electromagnetic interference by maintaining a minimum distance between portable and mobile RF communications equipment (transmitters) and the Genadyne DUO NPWT as recommended below, according to the maximum output power of the communications equipment.

Rated Maximum Output Power of Transmitter W	Separation Distance According to Frequency of Transmitter (m)		
	150 kHz to 80 MHz	80 MHz to 800 MHz	800 MHz to 2.5 GHz
0.01	Not Applicable	0.12 m	0.23 m
0.1	Not Applicable	0.37 m	0.74 m
1	Not Applicable	1.17 m	2.34 m
10	Not Applicable	3.70 m	7.40 m
100	Not Applicable	11.70 m	23.40 m

25. CONTACT INFORMATION



Genadyne Biotechnologies, Inc. 16 Midland Avenue
Hicksville, NY 11801 USA



Toll Free +1.800.208.2025

Tel. +1.516.487.8787

Fax +1.516.487.7878

2292

www.genadyne.com



Obelis S.A.

EU Representative Bd. General Wahis 53 BELGIUM

+32 (0) 2.732.59.54 (Tel)

+32 (0) 2.732.60.03 (Fax)

www.obelis.net

26. LABEL

GENADYNE

DUO NPWT SYSTEM

MD

REF

A7-S0001

EC

REP

OBELIS S.A
Bd. General Wahis 53 1030
Brussels, Belgium
Tel: +(32) 2 732-59-54
Fax: +(32) 2 732-60-03
Email: mail@obelis.net

Genadyne Biotechnologies, Inc.
16 Midland Ave, Hicksville
NY 11801 USA
Tel: +1.516.487.8787
Fax: +1.516.487.7878
www.genadyne.com

SN

IP30

Rx Only

30°C

DUO NPWT System
only for use with DUO
wound kits and canisters

2292

(01)
(21)
(11)

Power Adapter: ATM065T-P190/100-240 V, 50-60 Hz
Input: 19 VDC --- Power Max:3.43 A



















LTH-001 Release Date: 07.05.2018
Rev 12 Rev Date: 12.18.2024

Figure 50 DUO Device Label



Corporate Headquarters
1750 Oak Street Lakewood, NJ 08701
(732) 367-5533
www.handrhealthcare.com

Label Symbol Description

Symbol	Description	Symbol	Description
	Manufacturer		Type B Applied Part
	Date of Manufacture		Class II
	European Representative		Recycle: Electronic Equipment
	Catalog Number		Objects larger than 2.5 mm in diameter cannot come into contact with the inside of the device.
	Serial Number		Fragile
	Consult Instruction for Use		Prescription Only
	Caution		Medical Device
	Do not store the device above 30 Celsius.		CE Certificate/ Notified Body
	UDI carrier (DI & PI) Datamatrix (01) GTIN Number (21) Serial Number (11) Production Date		Not Safe to have near magnetic resonance equipment.